

SECTION – 09

Orthopaedics *ортопедия*





ST.THOMAS
09-001-160
16 cm
Pointed



ST.THOMAS
09-002-160
16 cm
Rounded



ROBINSON'S
09-003-170
17 cm



WILLIGER
09-004-160
16 cm



LANE
09-005-160
16 cm
Serrated



LANE
09-006-270
27 cm



TRETHOWAN'S
09-007-220
22 cm



BRISTOW'S
09-008-240
24 cm



SEDILLOT
09-009-210
21 cm



LANGENBECK
09-010-180
18 cm



LANGENBECK
09-011-190
19 cm

HOHMANN
09-012-150
15 cm

HOHMANN
09-013-154
15.4 cm
Short tip

PERIOSTEAL ELEVATOR
17.5 cm
For Metacarpals Small
6 mm width
09-014-175
For Metacarpals Medium
10 mm width
09-015-175
Light Curve, Rounded End,
09-016-175
5 mm width
Contra Angled Curve
09-017-175
4.5 mm width



BUCK GRAMCKO
09-018-180 18 cm
Small, width 6 mm
short, narrow tip

BUCK GRAMCKO
09-019-180 18 cm
Small, width 8 mm
short, narrow tip

HOHMANN
09-020-200 20 cm
Width 8 mm
short, narrow tip

HOHMANN
09-021-200 20 cm
Width 18 mm short, narrow tip
09-022-200 20 cm
Width 18 mm long, narrow tip

HOHMANN
09-023-160 16 cm
For Small Fragments
Board Shank



HOHMANN
09-024-180 18 cm
Width 43 mm
narrow tip
09-025-180 18 cm
Width 70 mm
narrow tip

HOHMANN
09-026-180 18 cm
Width 43 mm
long shank, angled

HOHMANN
09-027-160 16 cm
Width 22 mm
wide tip

HOHMANN
09-028-160 16 cm
long wire tip for Hip
Surgery, width 24 mm

**LANGE-
HOHMANN**
09-029-240
24 cm

BENNETT
09-030-260
26 cm, 65 mm



BLOUNT
09-031-270
27 cm, Blunt

AUFRANC
09-032-290
29 cm

AUFRANC
09-033-290
29 cm

AUFRANC
09-034-290
29 cm



09-036-190
19 cm, 13 mm
09-037-200
20 cm, 20 mm
09-038-230
23 cm, 25 mm
09-039-250
25 cm, 31 mm

1/3

CHANDLER
09-035-250
25 cm

1/2

**HOEN
PERIOSTEAL**
09-040-165
16.5 cm

1/2

**KEY
PERIOSTEAL**
09-041-180
18 cm, Tip 1/2"

1/2

**KEY
(Fig.A)**

09-042-190 19 cm, 3 mm
09-043-190 19 cm, 6 mm
09-044-190 19 cm, 9 mm
09-045-190 19 cm, 12 mm
09-046-190 19 cm, 15 mm
09-047-190 19 cm, 19 mm
09-048-190 19 cm, 25 mm

1/3

**COBB
Elevators**
09-049-234
23.4 cm
Hex Handle

SEMB
09-050-195 – 09-054-195
255 mm
22 3/4 cm

09-050-195
195 mm
19.5 cm

09-051-195

09-052-195

09-053-195

09-054-195



09-055-200 20 cm
Medium straight
blade round edge,
width 14 mm

09-056-200 20 cm
Medium curved
blade round edge,
width 14 mm

09-057-180 18 cm
Small curved
blade round edge,
width 6 mm

09-058-180 18 cm
Small curved
blade round edge,
width 6 mm

09-059-180
18 cm
Extra small
curved blade
round edge,
width 3 mm

09-060-200
20 cm
Large straight
blade round edge,
width 20 mm

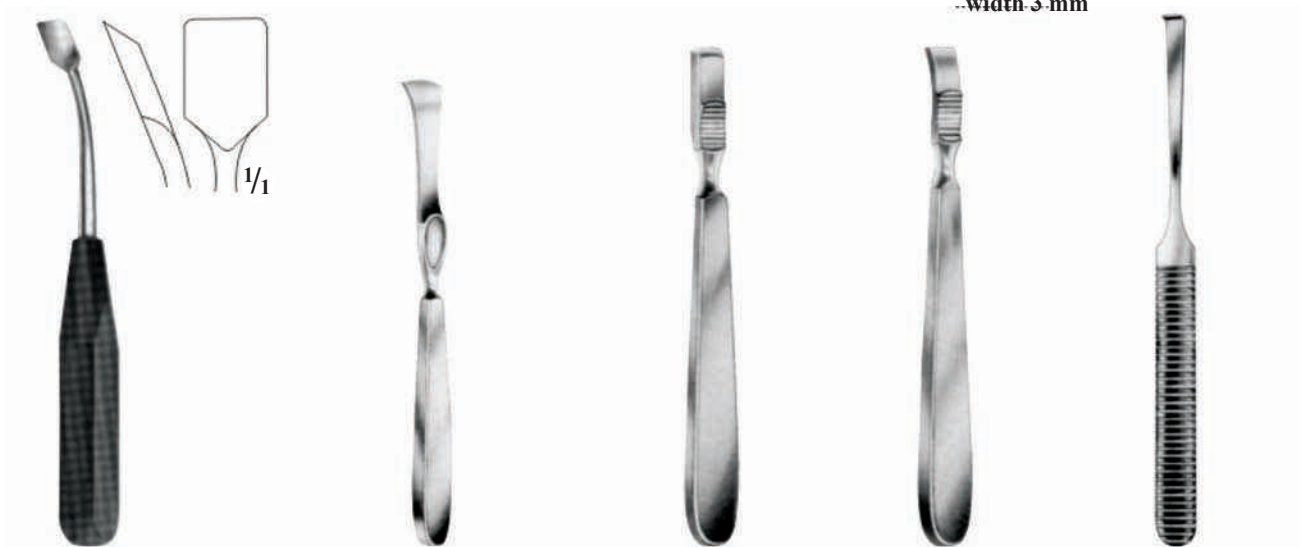

Straight Edge, 14 mm
09-061-185
Straight 18.5 cm
09-062-185
Curved 18.5 cm

LAMBOTTE 20 cm
09-063-210 1.0 cm
09-064-210 1.5 cm
09-065-210 2.0 cm

FARABEU
09-066-150
15 cm

FARABEU
09-067-150
15 cm

MANNERFELT modif
09-068-160 5 mm
09-069-160 6 mm
09-070-160 7 mm
16 cm



ALEXANDER
09-071-200
20 cm

MATSON
09-072-220
22 cm

JOSEPH
09-073-170
17 cm
with plastic handle

6 mm 09-074-170
1/1
6 mm 09-075-170

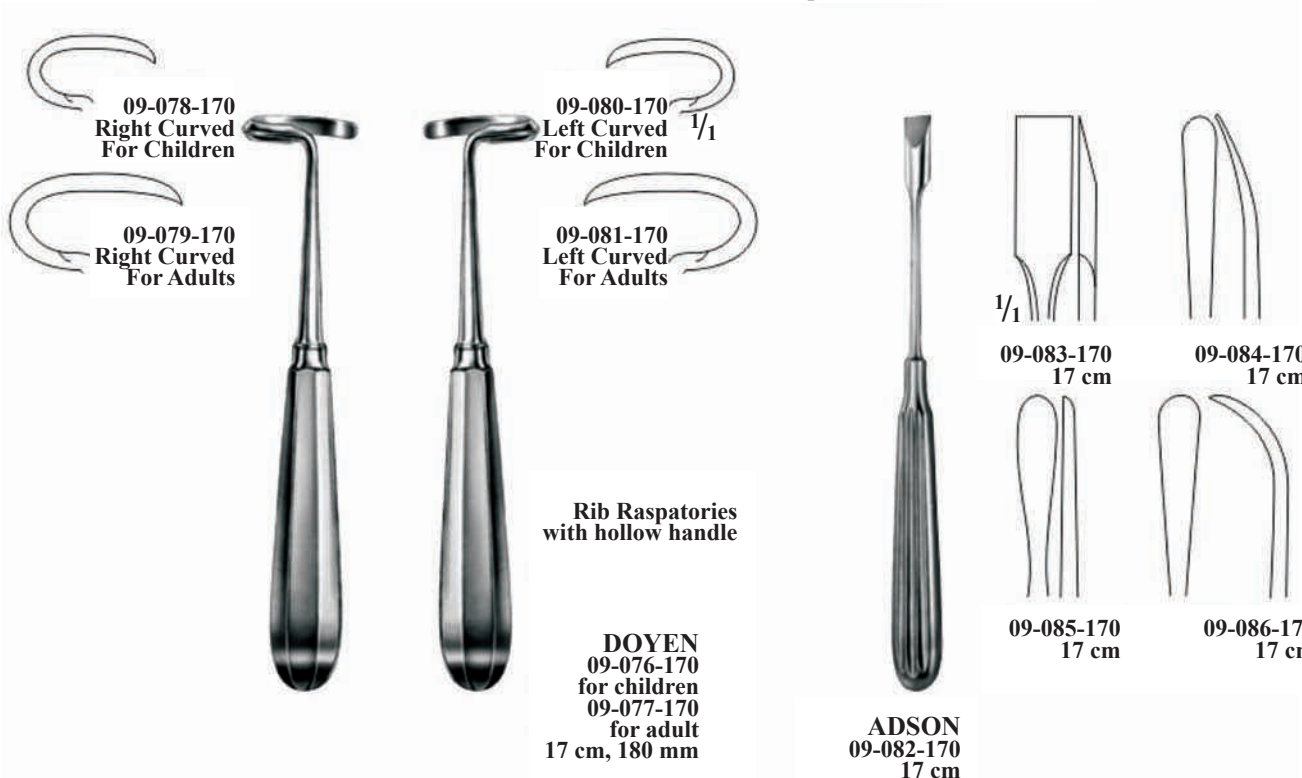

09-078-170
Right Curved
For Children

09-080-170
Left Curved
For Children

09-079-170
Right Curved
For Adults

09-081-170
Left Curved
For Adults

Rib Raspatories
with hollow handle

DOYEN
09-076-170
for children
09-077-170
for adult
17 cm, 180 mm

ADSON
09-082-170
17 cm

1/1
09-083-170
17 cm
09-084-170
17 cm

09-085-170
17 cm
09-086-170
17 cm



GALLAHER
09-087-177
17.7 cm
180 mm



PUTTI
09-088-280
28 cm



PUTTI
09-089-300
30 cm



BONE TAMPS
09-090-154
15.4 cm
Tip Dia. 10 mm



09-091-240
24 cm
240 mm



FOMAN RASP
09-092-210
21 cm



MILLER-COLBURN
09-093-180
18 cm

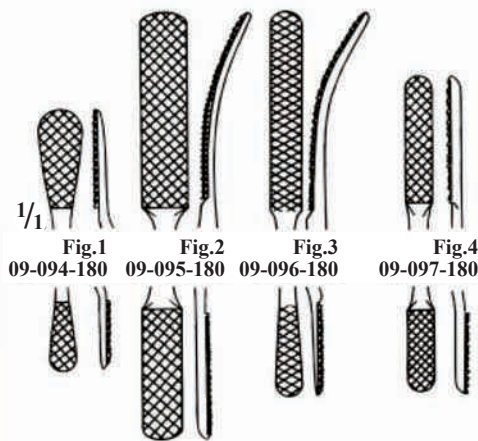

cross cut



MILLER FILE
09-098-190
19 cm



MILLER FILE
09-099-190
19 cm



09-100-170 17 cm 000	09-101-170 17 cm 00
09-102-170 17 cm 0	09-103-170 17 cm 1
09-104-170 17 cm 2	09-105-170 17 cm 3
09-106-170 17 cm 4	09-107-170 17 cm 5
1/1	
09-108-170 17 cm 6	

BRUNS
1/2



09-109-170 17 cm 0000	09-110-170 17 cm 000	09-111-170 17 cm 00
09-112-170 17 cm 0	09-113-170 17 cm 1	09-114-170 17 cm 2
09-115-170 17 cm 3	09-116-170 17 cm 4	09-117-170 17 cm 5
1/1		
09-118-170 17 cm 6		

VOLKMANN
1/2



1/1 09-119-240 Fig.1
09-120-240 Fig.2
09-121-240 Fig.3
09-122-240 Fig.4
09-123-240 Fig.5
09-124-240 Fig.6

SIMON
24 Cm
1/3



09-125-225 22.5 cm 000	09-126-225 22.5 cm 00
09-127-225 22.5 cm 0	09-128-225 22.5 cm 1
09-129-225 22.5 cm 2	09-130-225 22.5 cm 3
09-131-225 22.5 cm 4	09-132-225 22.5 cm 5
1/1	
09-133-225 22.5 cm 6	

**HIBBS-SPRATT /
ANGLED**
1/3



09-134-225 22.5 cm 000	09-135-225 22.5 cm 00
09-136-225 22.5 cm 0	09-137-225 22.5 cm 1
09-138-225 22.5 cm 2	09-139-225 22.5 cm 3
09-140-225 22.5 cm 4	09-141-225 22.5 cm 5
1/1	
09-142-225 22.5 cm 6	

**HIBBS-SPRATT /
STRAIGHT**
1/3

UFFENORDE LEFT
09-143-175
17.5 cm
1/2

UFFENORDE RIGHT
09-144-175
17.5 cm
1/2



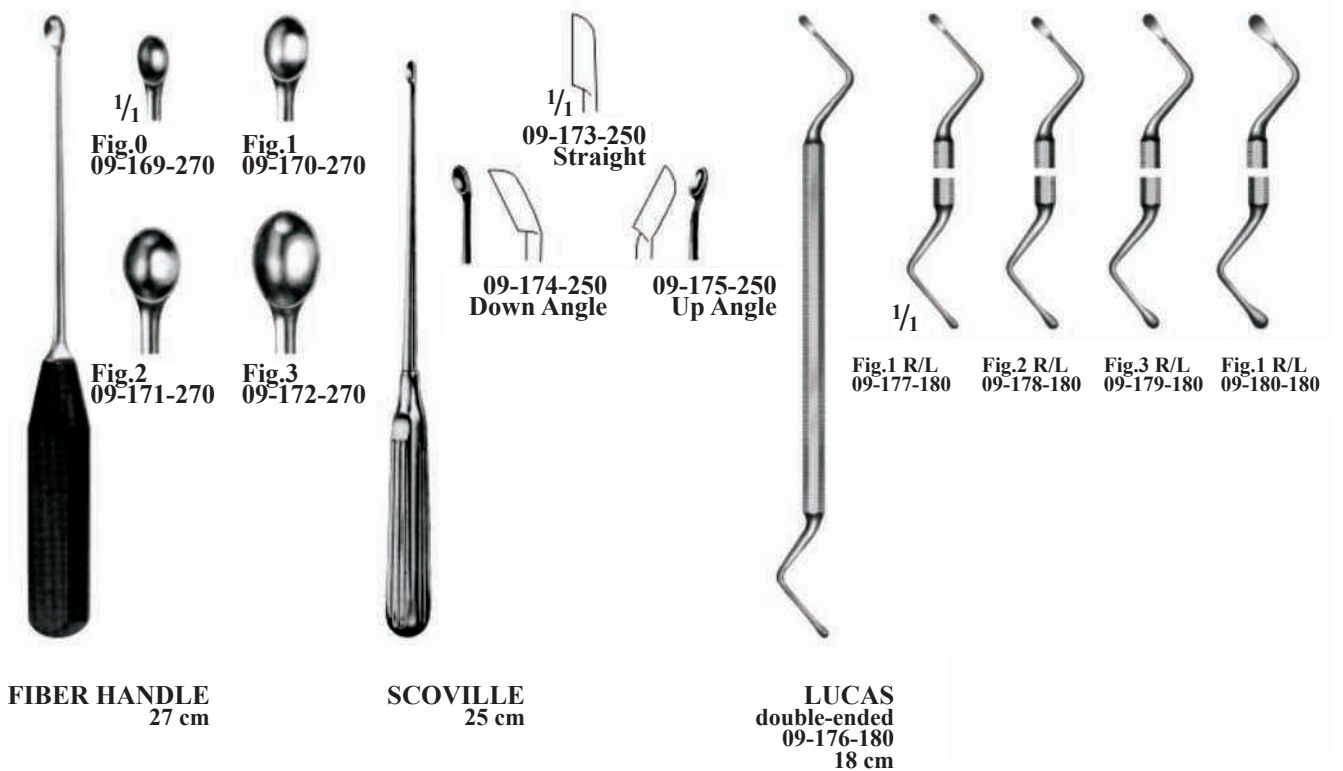
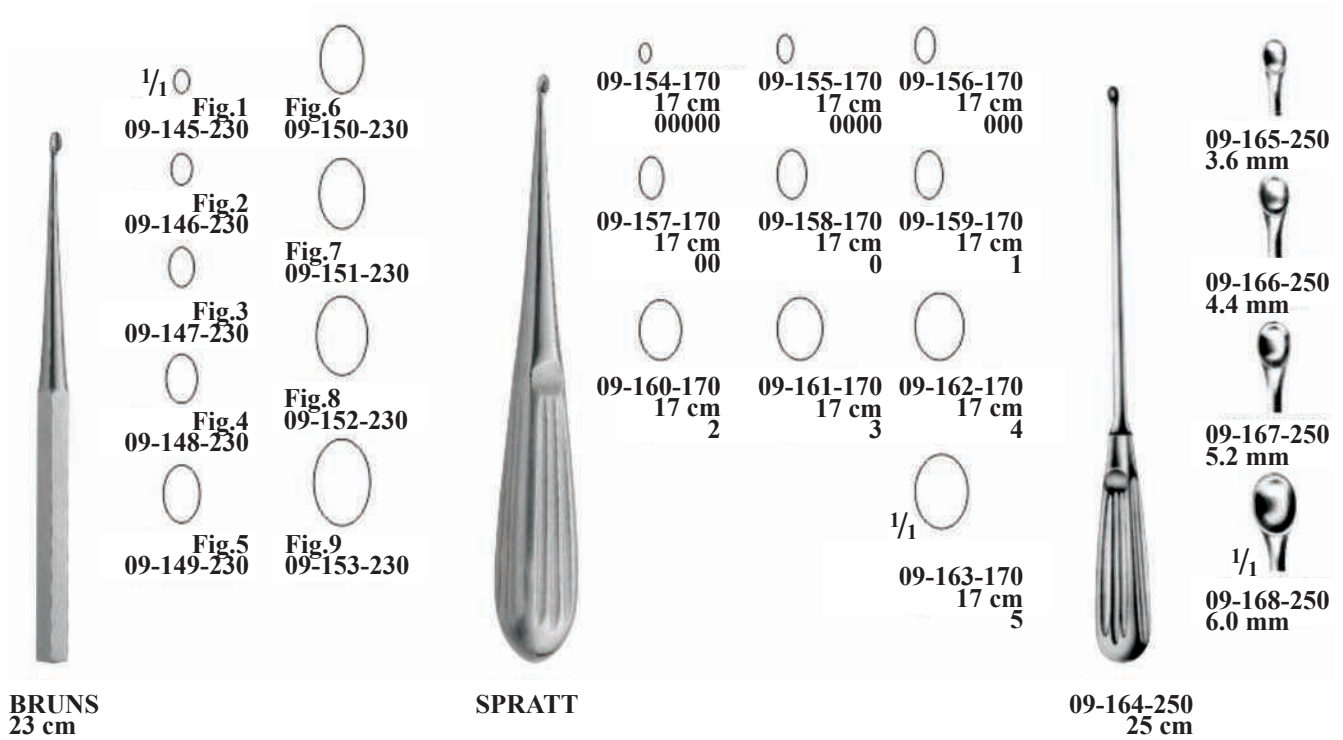

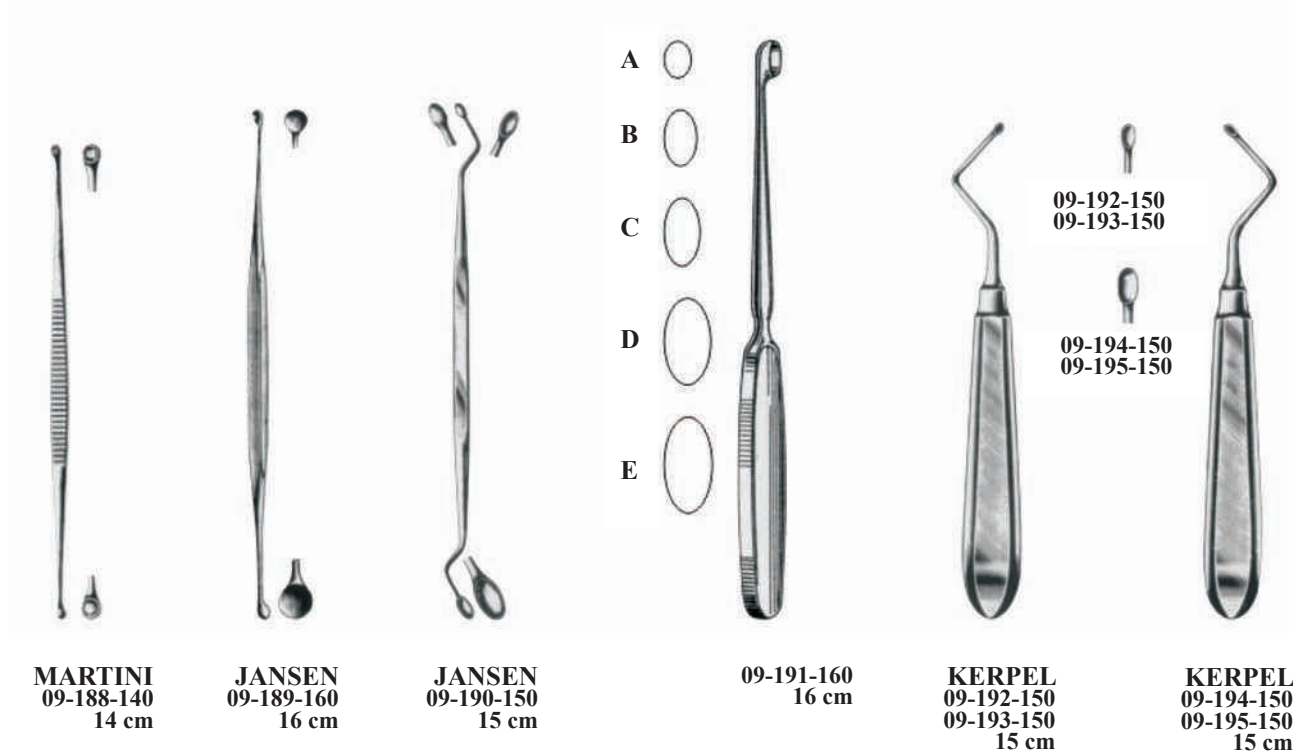
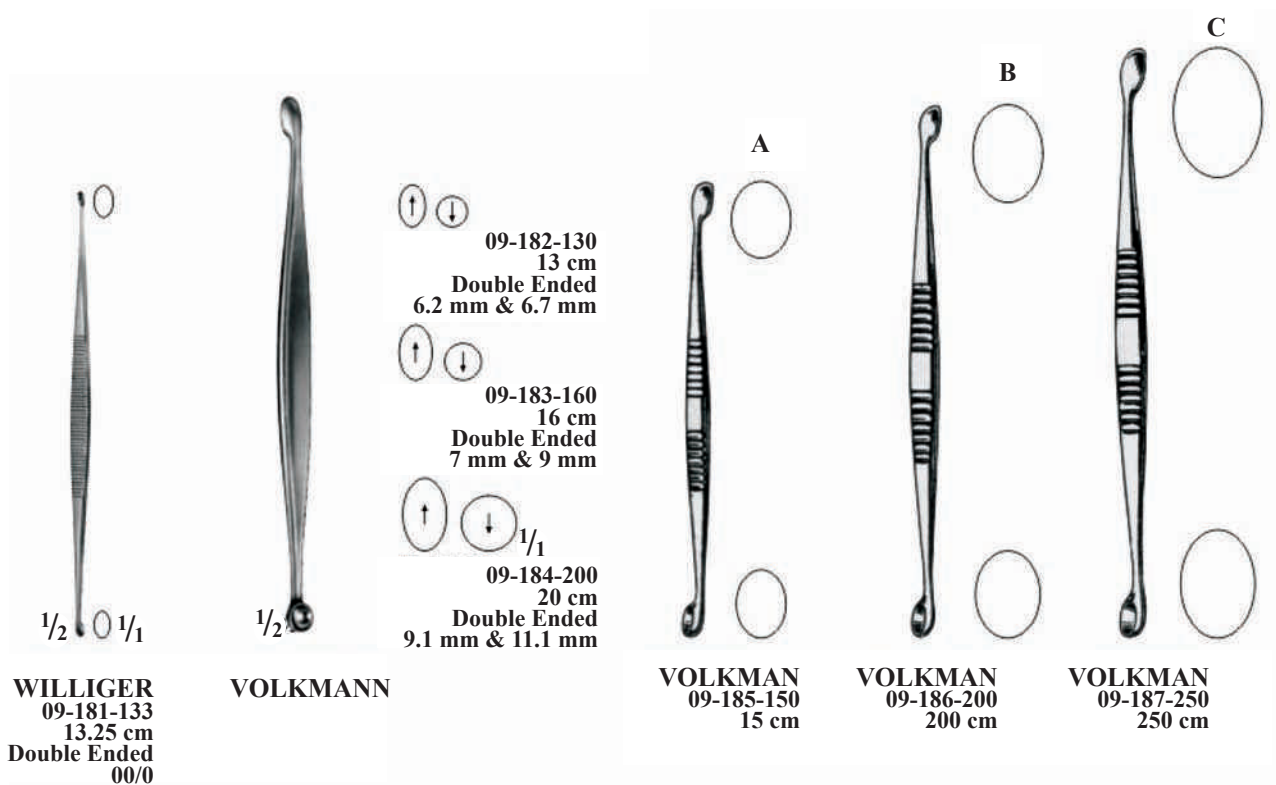

1/3
plane (nylon)
convex (steel)
plastic handle
Head 30 mm Ø
Weight 675 Gr.

MALLET
09-196-265
26.5 cm

1/3
plastic handle
Head 42 / 30 mm Ø
Weight 530 Gr.

MALLET
09-197-260
26 cm

1/3
plastic handle
Head 30 mm Ø
Weight 480 Gr.

MALLET
09-198-240
24 cm

1/3
plastic handle
Head 30 mm Ø
Weight 510 Gr.

MALLET
09-196-260
26 cm



Spare Facing (pair)
09-201-00
plastic

1/3
disks and plastik handle
Head 37 mm Ø
Weight 370 Gr.

MALLET
09-200-240
24 cm

1/3
made of plastik
Head 30 mm Ø
Weight 125 Gr.

MALLET
09-202-220
22 cm

1/3
made of plastik
with lead filling
Head 42 mm Ø
Weight 400 Gr.
Head 42 mm Ø
Weight 250 Gr.

MALLET
09-203-260
26 cm

1/3
made of plastik
with lead filling
Head 42 mm Ø
Weight 400 Gr.

MALLET
09-204-260
26 cm

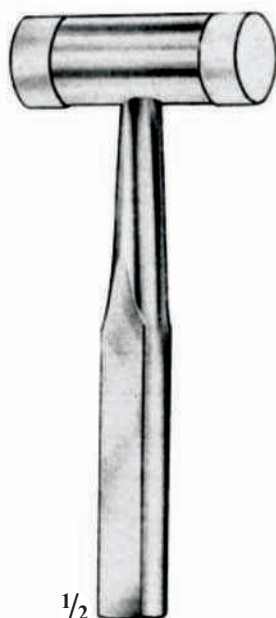

$\frac{1}{2}$
**ORTO / WITH
PLASTIC CAPS**
09-205-180
18 cm
25 mm Dia.
5OZ (140g)



$\frac{1}{3}$
HAJEK
09-206-223
22.25 cm
27 mm Dia.
5OZ (140g)



$\frac{1}{3}$
BERGMANN
09-207-240
24 cm
10 1/4OZ (300g)



$\frac{1}{2}$
COTTLE
09-208-190
19 cm
8 1/2OZ (240g)



$\frac{1}{3}$
COLLIN
09-209-230
23 cm
33 mm Dia.
7 3/4OZ (220g)

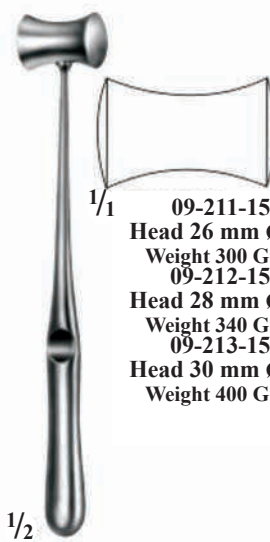

$\frac{1}{1}$
WILLIGER
09-211-155
Head 26 mm Ø
Weight 300 Gr.
09-212-155
Head 28 mm Ø
Weight 340 Gr.
09-213-155
Head 30 mm Ø
Weight 400 Gr.
 $\frac{1}{2}$
09-210-155
15.5 cm



09-215-205
Head 25 mm Ø
Weight 120 Gr.
09-216-205
Head 30 mm Ø
Weight 180 Gr.
09-217-205
Head 35 mm Ø
Weight 260 Gr.

1/2

DOYEN
09-214-205
20.5 cm

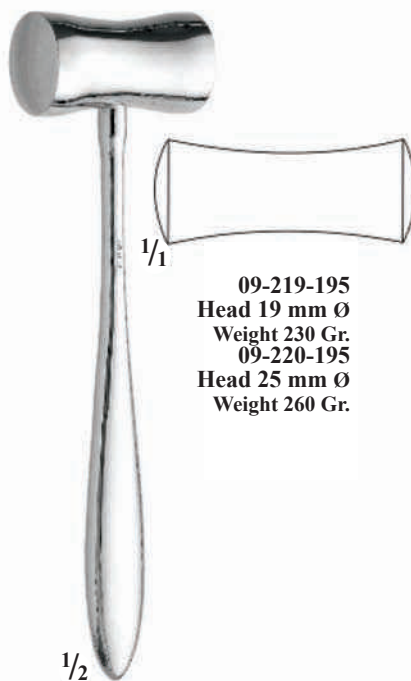

09-219-195
Head 19 mm Ø
Weight 230 Gr.
09-220-195
Head 25 mm Ø
Weight 260 Gr.

1/2

LUCAE
09-218-195
19.5 cm



1/2

WILLIGER
09-221-165
16.5 cm
Head 20 mm Ø
weight 140 Gr.



1/2

PARTSCH
09-222-190
19 cm

Head 22 mm Ø
Lead Filled



1/2

MEAD
09-223-190
19 cm

Spare Facings
09-225-190

09-224-190
with interchangeable
Plastic dicks
Head 27 mm Ø
Weight 320 Gr.

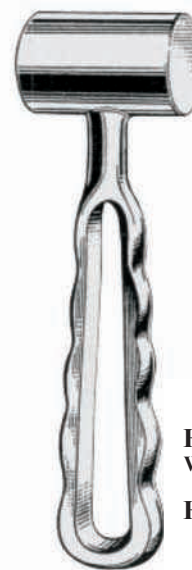

HEATH

09-226-160
16 cm
Head 3.5 cm Ø
Weight 510.27 Gr.
09-227-165
Head 4.5 cm Ø
Weight 793 Gr.

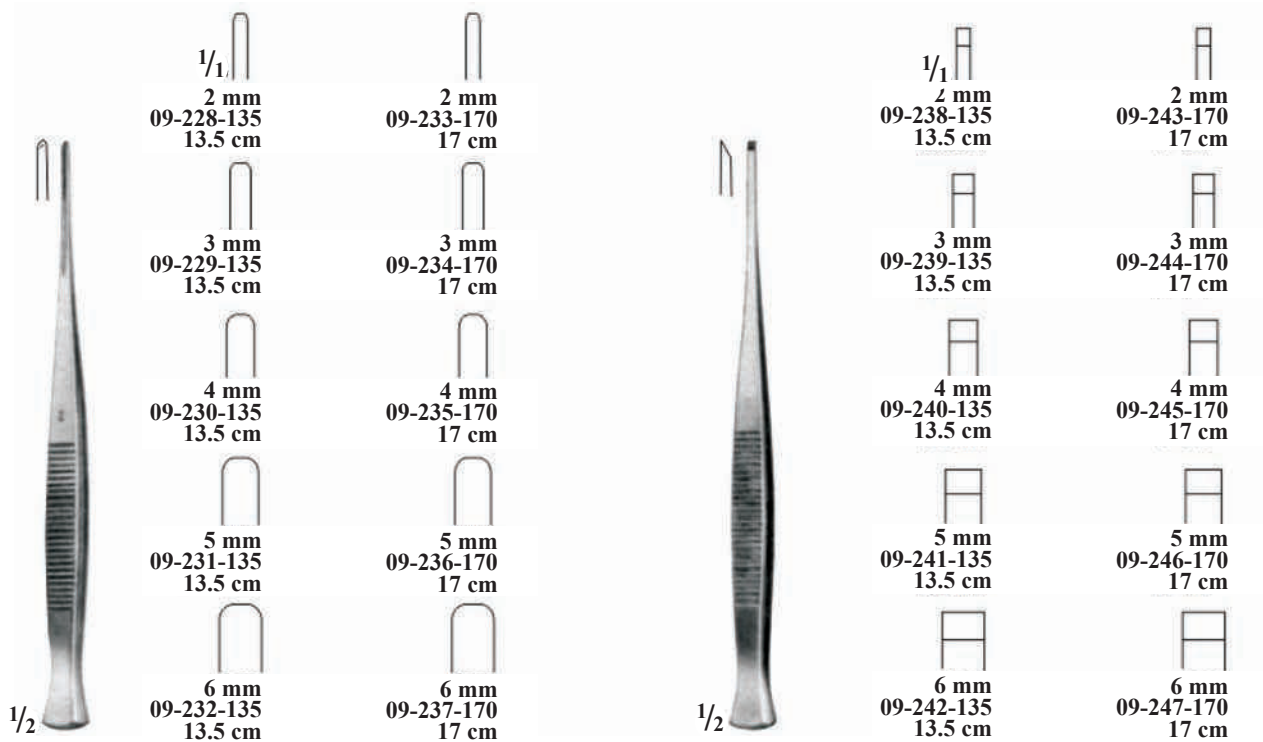

PARTSCH

PARTSCH

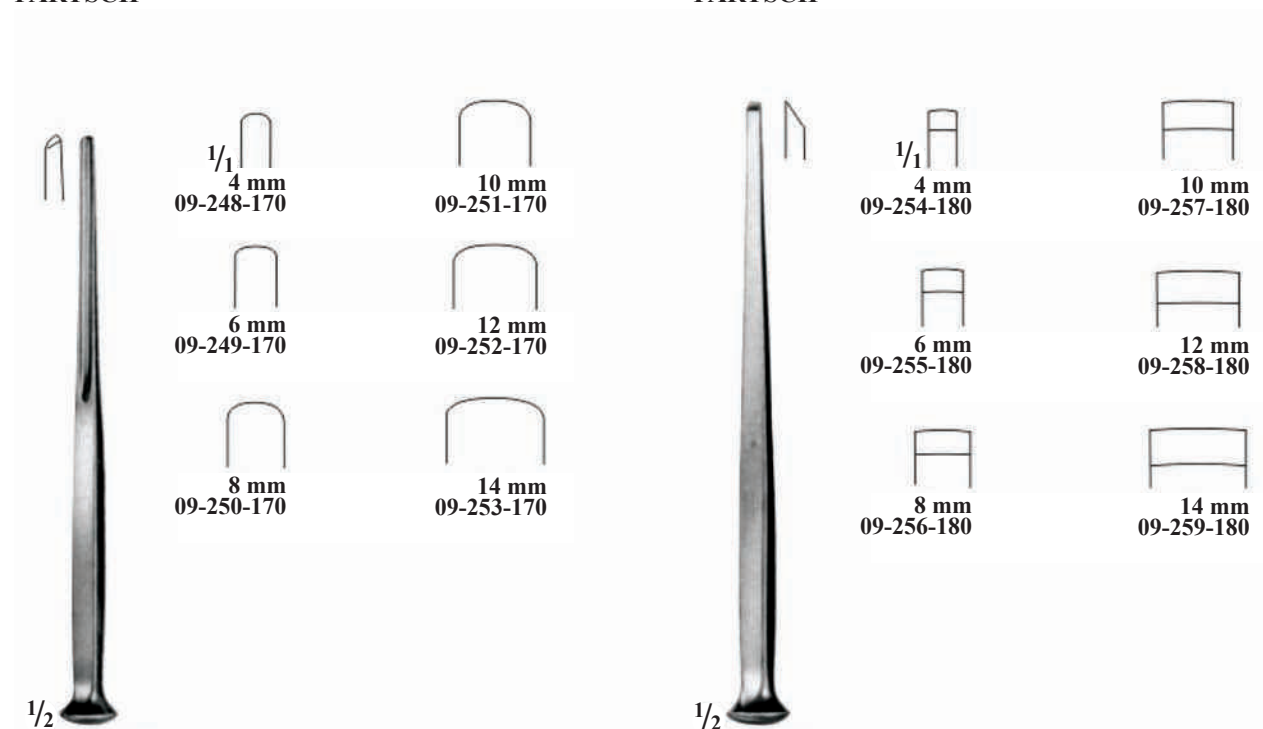

ALEXANDER
17 cm

ALEXANDER
18 cm

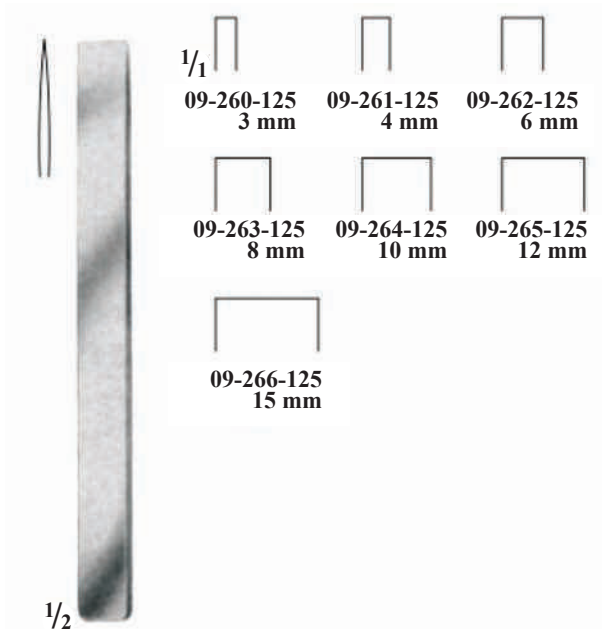

MINI-LAMBOTTE
12.5 cm

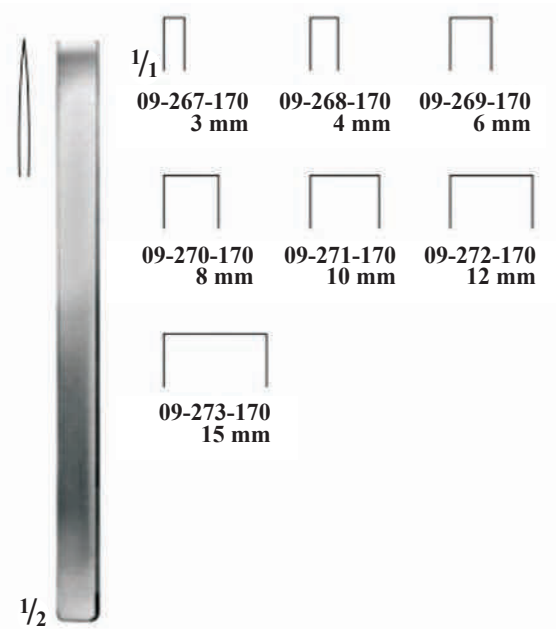

MINI-LAMBOTTE
17 cm

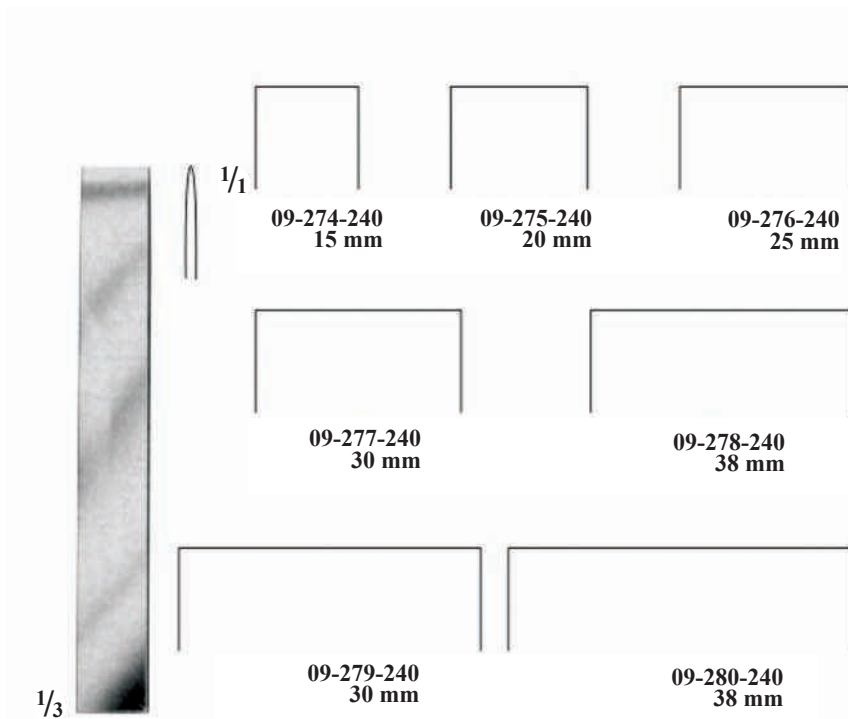

LAMBOTTE
24 cm



LAMBOTTE
23 cm

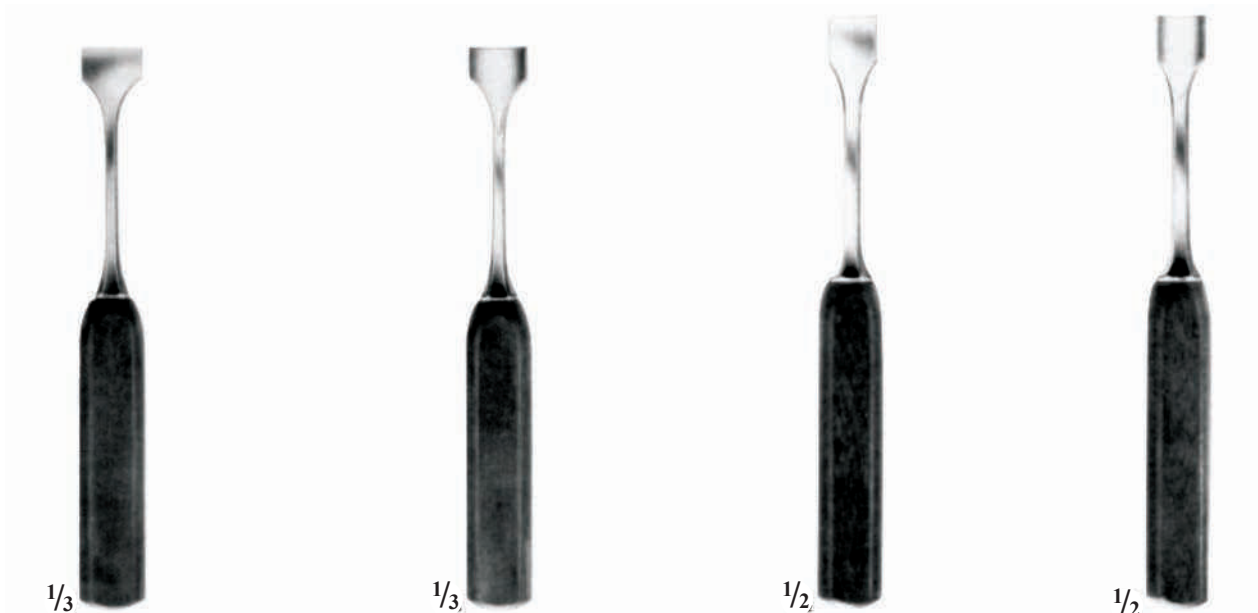

LEXER FLAT
09-288-220 1.0 cm
09-289-220 1.5 cm
09-290-220 2.0 cm
09-291-220 2.5 cm
22 cm Tip size

LEXER HOLLOW
09-292-220 1.0 cm
09-293-220 1.5 cm
09-294-220 2.0 cm
09-295-220 2.5 cm
22 cm Tip size

MINI LEXER
09-296-180
18 cm

MINI LEXER
09-297-180
18 cm
Hollow

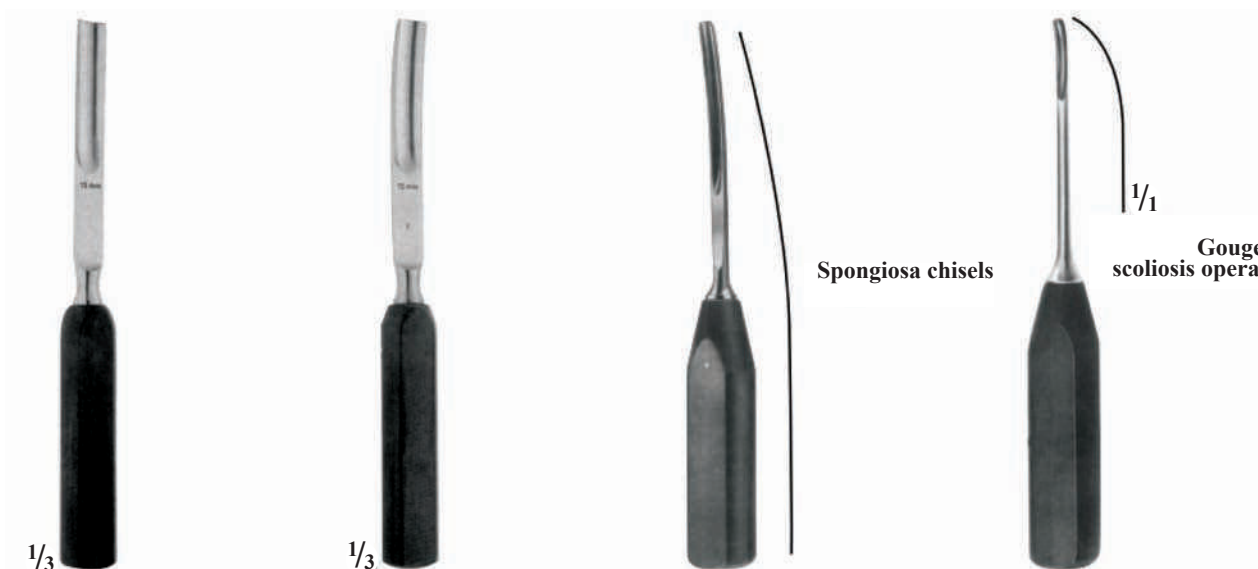

LEXER Straight
09-298-250 0.5 cm
09-299-250 1.0 cm
09-300-250 1.5 cm
25 cm Tip size

LEXER Curved
09-301-250 0.5 cm
09-302-250 1.0 cm
09-303-250 1.5 cm
25 cm Tip size

ZIELKE
09-304-250 5 cm
09-305-250 10 cm
09-306-250 15 cm
gebogen/curved
250 mm
25 cm

ZIELKE
09-307-230 5 cm
09-308-230 10 cm
230 mm
23 cm

SMITH PETERSON
20 cm

09-309-200	Straight	0.6 cm
09-310-200	Straight	0.9 cm
09-311-200	Straight	1.2 cm
09-312-200	Straight	1.5 cm
09-313-200	Straight	2.0 cm
09-314-200	Straight	2.5 cm
09-315-200	Straight	3.0 cm
09-316-200	Curved	0.6 cm
09-317-200	Curved	0.9 cm
09-318-200	Curved	1.2 cm
09-319-200	Curved	1.5 cm
09-320-200	Curved	2.0 cm
09-321-200	Curved	2.5 cm
09-322-200	Curved	3.0 cm

SMITH PETERSON
20 cm

09-323-200	0.6 cm
09-324-200	0.9 cm
09-325-200	1.2 cm
09-326-200	1.5 cm
09-327-200	2.0 cm
09-328-200	2.5 cm
09-329-200	3.0 cm

STILLE
20 cm

09-330-200	Straight	1.0 cm
09-331-200	Straight	1.2 cm
09-332-200	Straight	1.5 cm
09-333-200	Straight	2.0 cm
09-334-200	Straight	2.5 cm
09-335-200	Curved	1.0 cm
09-336-200	Curved	1.2 cm
09-337-200	Curved	1.5 cm
09-338-200	Curved	2.0 cm
09-339-200	Curved	2.5 cm

STILLE
20 cm

09-340-200	1.0 cm
09-341-200	1.2 cm
09-342-200	1.5 cm
09-343-200	2.0 cm
09-344-200	2.5 cm

CHISELS

09-345-200	1.0 cm
09-346-200	1.2 cm
09-347-200	1.5 cm
09-348-200	2.0 cm
09-349-200	2.5 cm

OSTEOTOME

WALTER

09-350-200	10 cm
09-351-200	15 cm
	20 cm



REIL
09-352-170
17 cm



REDUCTION FORCEPS
09-353-200
20 cm



09-354-170
17 cm



09-355-130
13 cm



LEWIN

09-356-175
17.5 cm



REDUCTION
09-357-130
13 cm

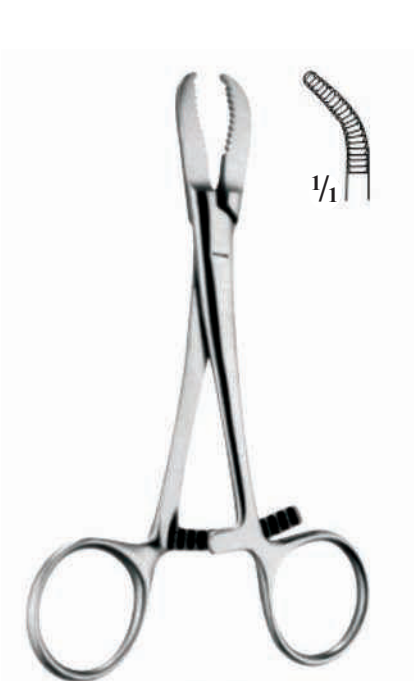

09-358-135
13.5 cm



DINGMANN
09-359-180
18 cm



09-360-160
16 cm



09-361-220
22 cm



PATELLA
09-362-185
18.5 cm



09-363-160 16 cm
09-364-240 24 cm
with Tread Lock



REPOSITION
09-365-230
23 cm



HEY GROVES
09-366-210 21 cm
09-367-270 27 cm
09-368-300 30 cm



LANE
09-369-330 33 cm
09-370-470 47 cm



LANE
09-371-330 33 cm
09-372-470 47 cm



KERN
09-373-160 16 cm with ratchet
09-374-210 21 cm with ratchet
09-375-160 16 cm without ratchet
09-376-210 21 cm without ratchet



FARABEU-F-LAMBOTTE
09-377-230 23 cm with ratchet
09-378-260 26 cm with ratchet
09-379-230 23 cm mm without ratchet
09-380-260 26 cm mm without ratchet



1/3

SELF-CENTERING

09-384-150
For small Fragments 15 cm, jaw 8 mm
09-385-190
19 cm, Extra small jaw 10 mm
09-386-240
24cm, small jaw 14 mm
09-387-260
26 cm, medium jaw 18 mm
09-388-280
28 cm, large jaw 23 mm



1/3

ULRICH

09-389-190 19 cm
09-390-230 23 cm
09-391-250 25 cm
09-392-280 28 cm



1/3

LAMBOTTE

09-393-220 22 cm
09-394-270 27 cm
09-395-330 33 cm



1/2

09-396-200
20 cm

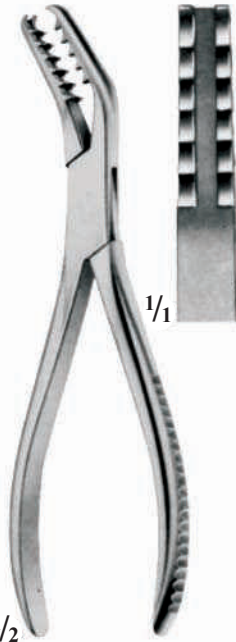

1/1

SEMB
09-397-190
19 cm



FERGUSON
09-398-230
23 cm

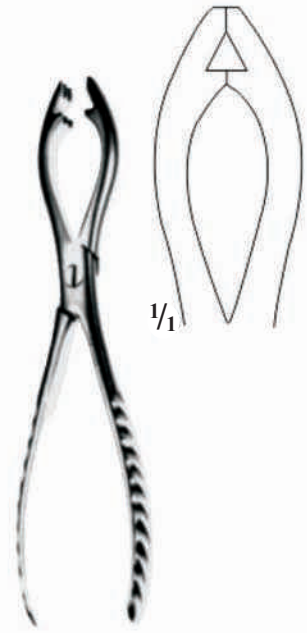

1/1

FERGUSON
09-399-210
21 cm

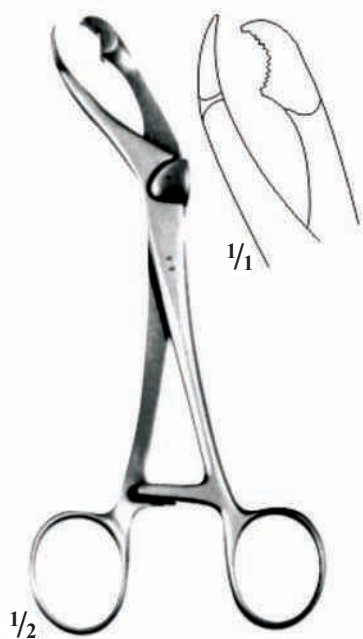

VERBRUGGE
09-400-180
18 cm

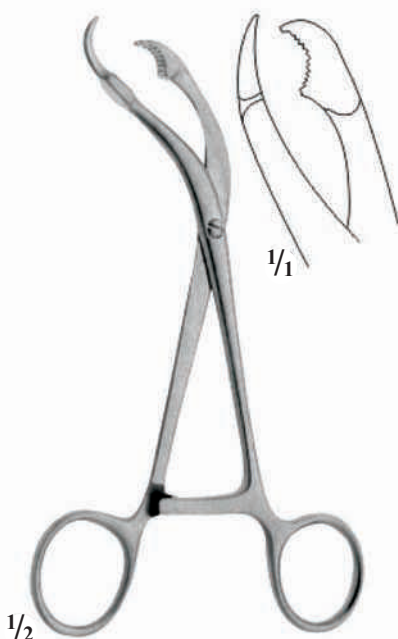

VERBRUGGE
09-401-180
18 cm



VERBRUGGE
09-402-250 25 cm
09-403-260 26 cm
09-404-270 27 cm



VERBRUGGE
09-405-250 25 cm
09-406-260 26 cm
09-407-270 27 cm



VERBRUGGE
09-408-180
18 cm



VERBRUGGE
09-409-250 25 cm
09-410-260 26 cm
09-411-270 27 cm

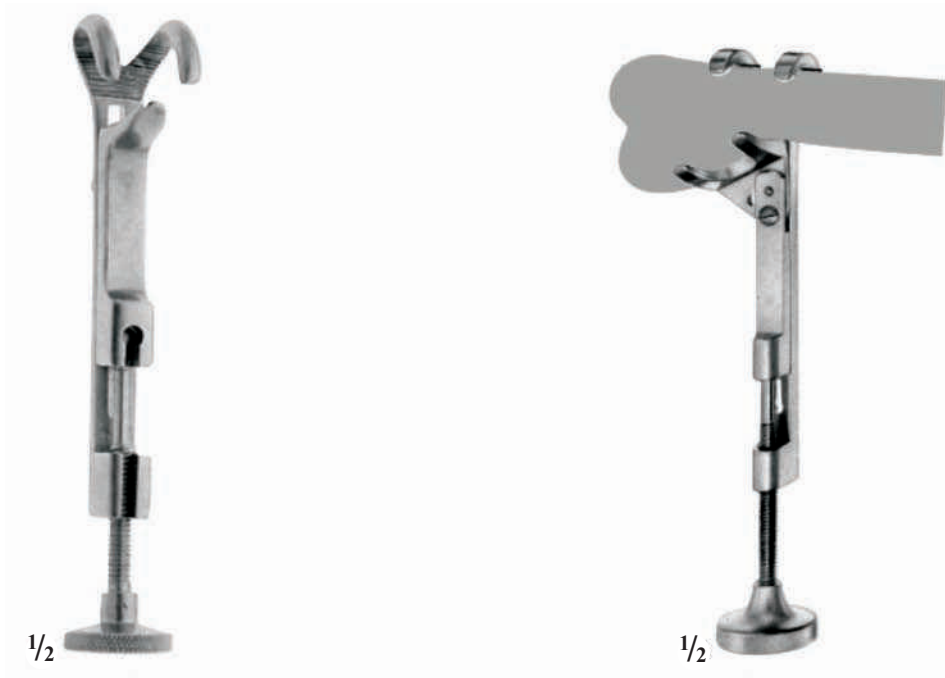

LOWMANN
09-412-130 13.0 cm
09-413-185 18.5 cm
09-414-300 30.0 cm

LOWMANN-HOGLUND
09-415-175
17.5 cm

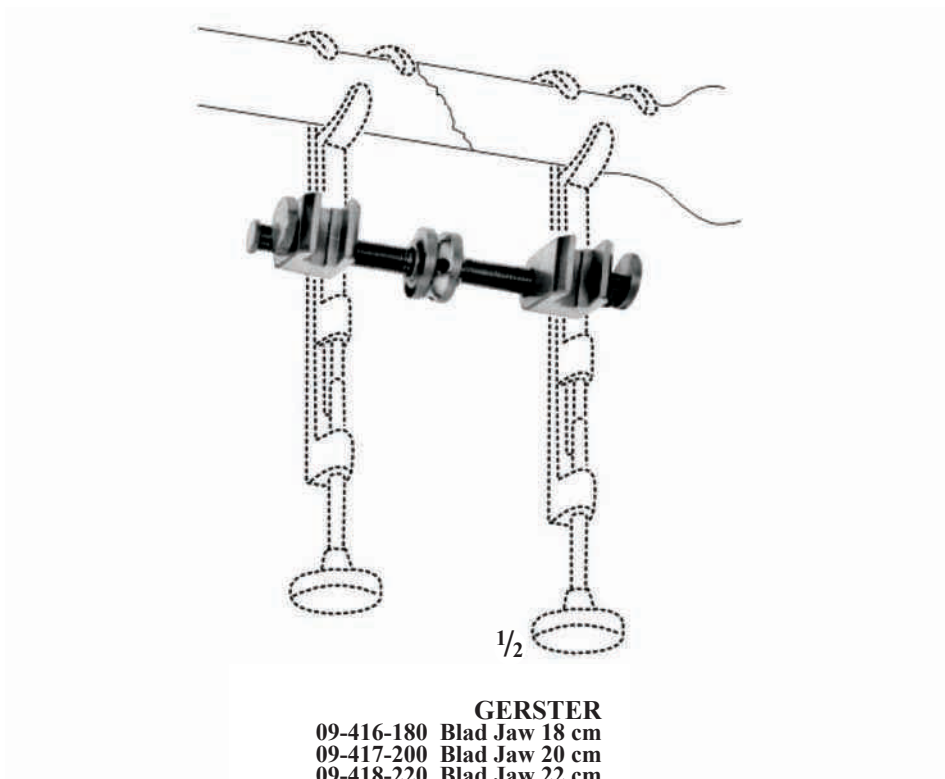

GERSTER
09-416-180 Blad Jaw 18 cm
09-417-200 Blad Jaw 20 cm
09-418-220 Blad Jaw 22 cm

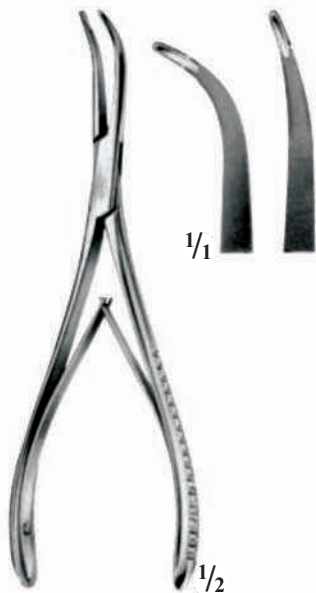

**STELLBRINK
SYNOVCTOMY**
09-419-175
17.5 cm

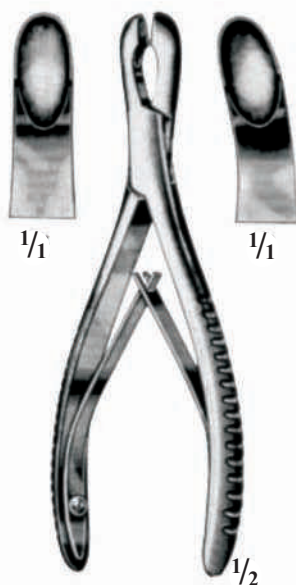

LUER
09-420-170 17 cm straight
09-421-170 17 cm curved



LEMPERT
09-422-190 19 cm straight
09-423-190 19 cm curved

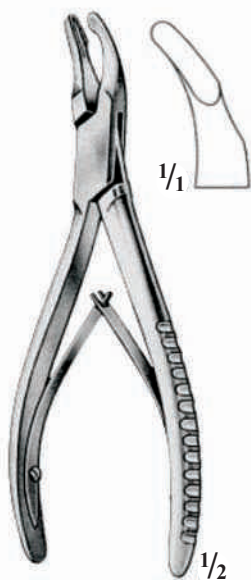

CLEVELAND
09-424-140 14 cm
09-425-170 17 cm

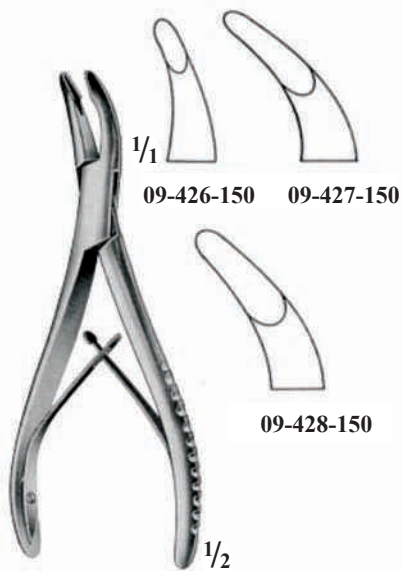

LUER
15 cm

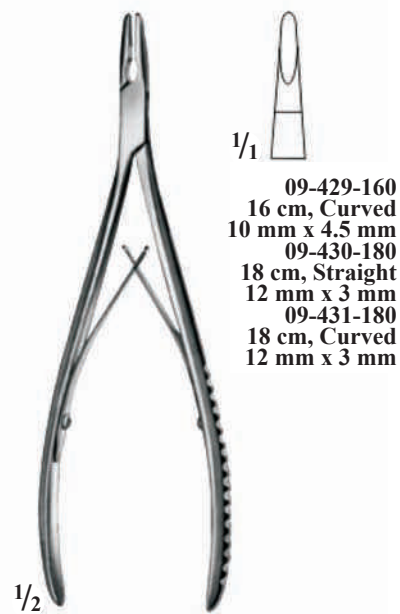

LEMPERT

09-429-160
16 cm, Curved
10 mm x 4.5 mm
09-430-180
18 cm, Straight
12 mm x 3 mm
09-431-180
18 cm, Curved
12 mm x 3 mm

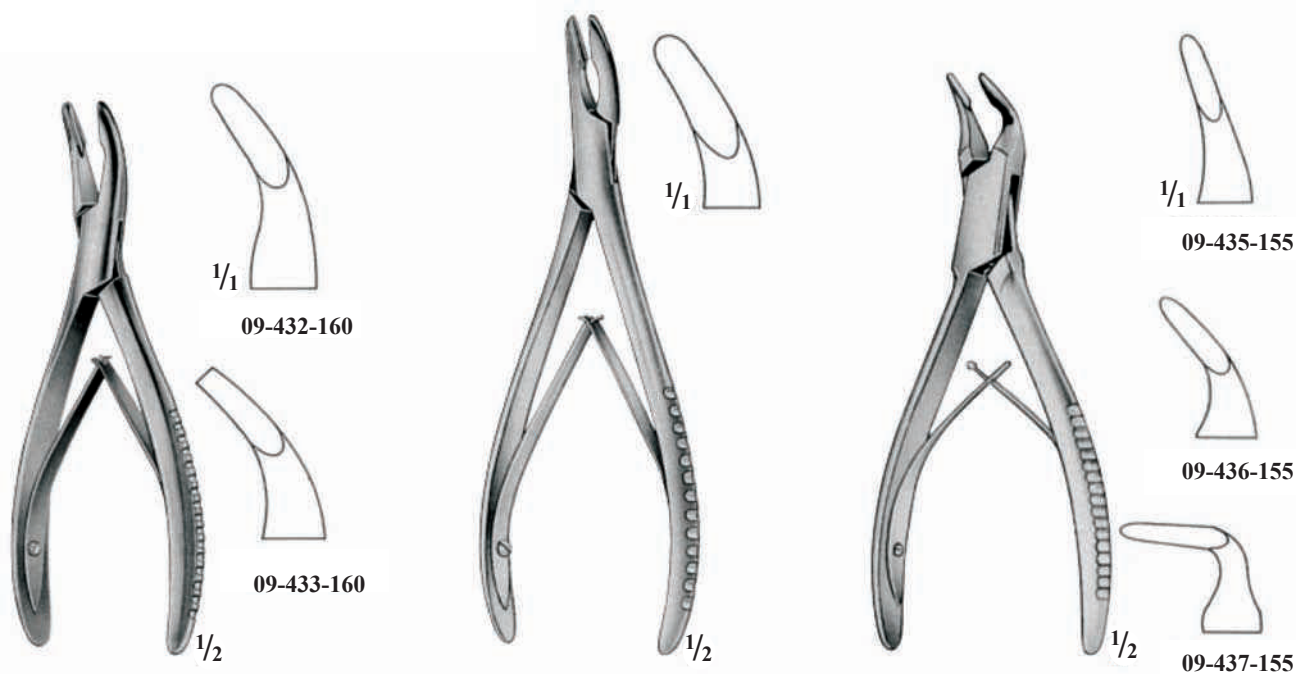

MEAD
16 cm

MARTMANN
09-434-185
18.5 cm

BLUMENTHAL
15.5 cm

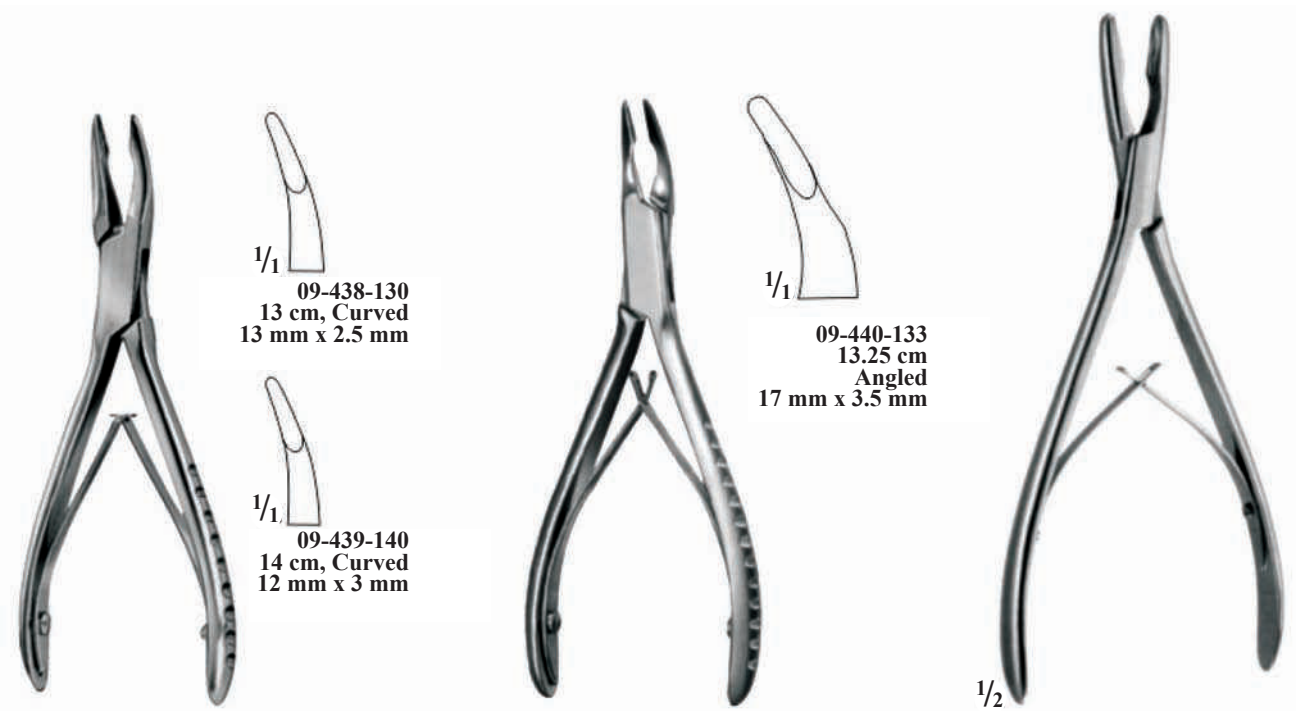

**FRIEDMANN &
MINI-FRIEDMAN**

UNIVERSAL

ADSON
09-441-20
20 cm, Straight
15 mm x 7.5 mm

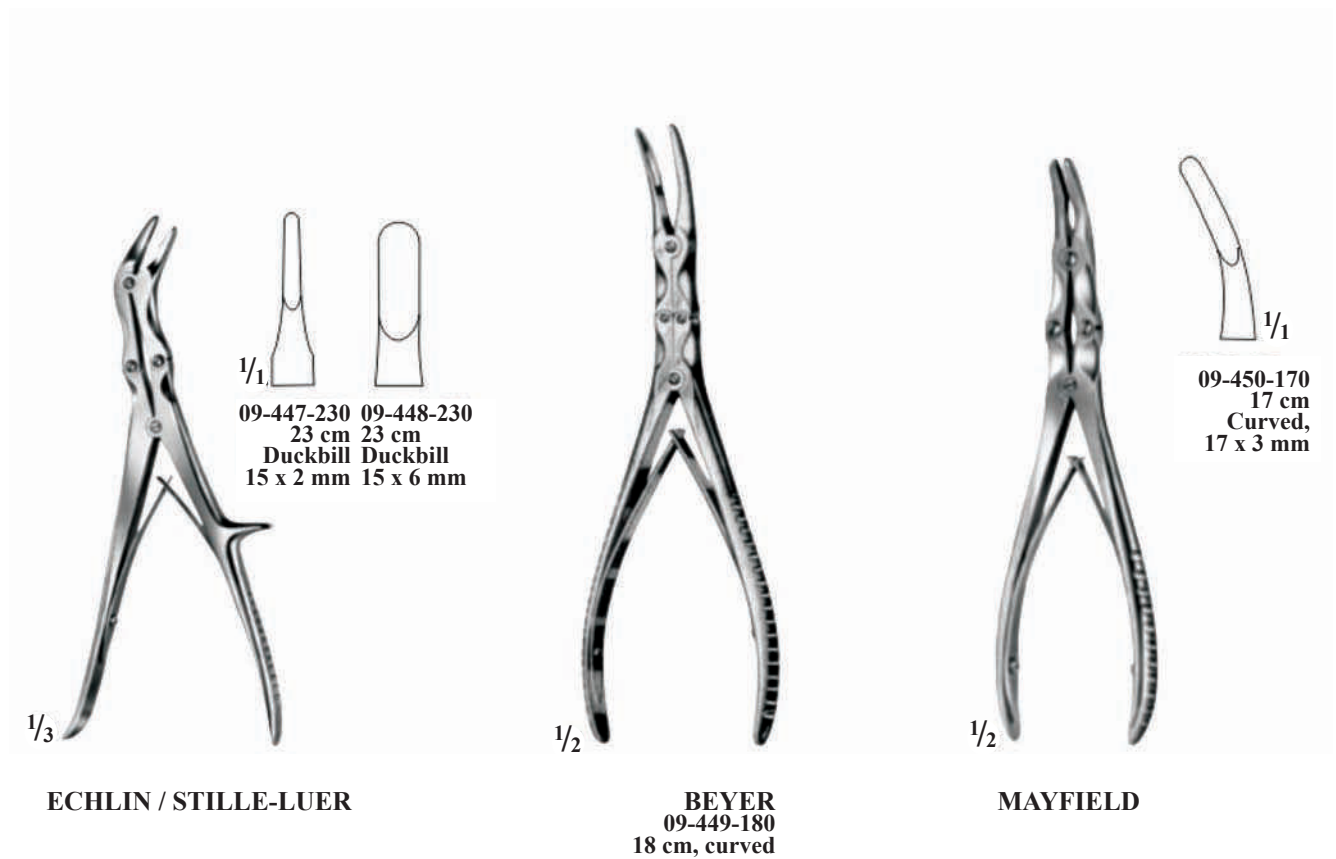
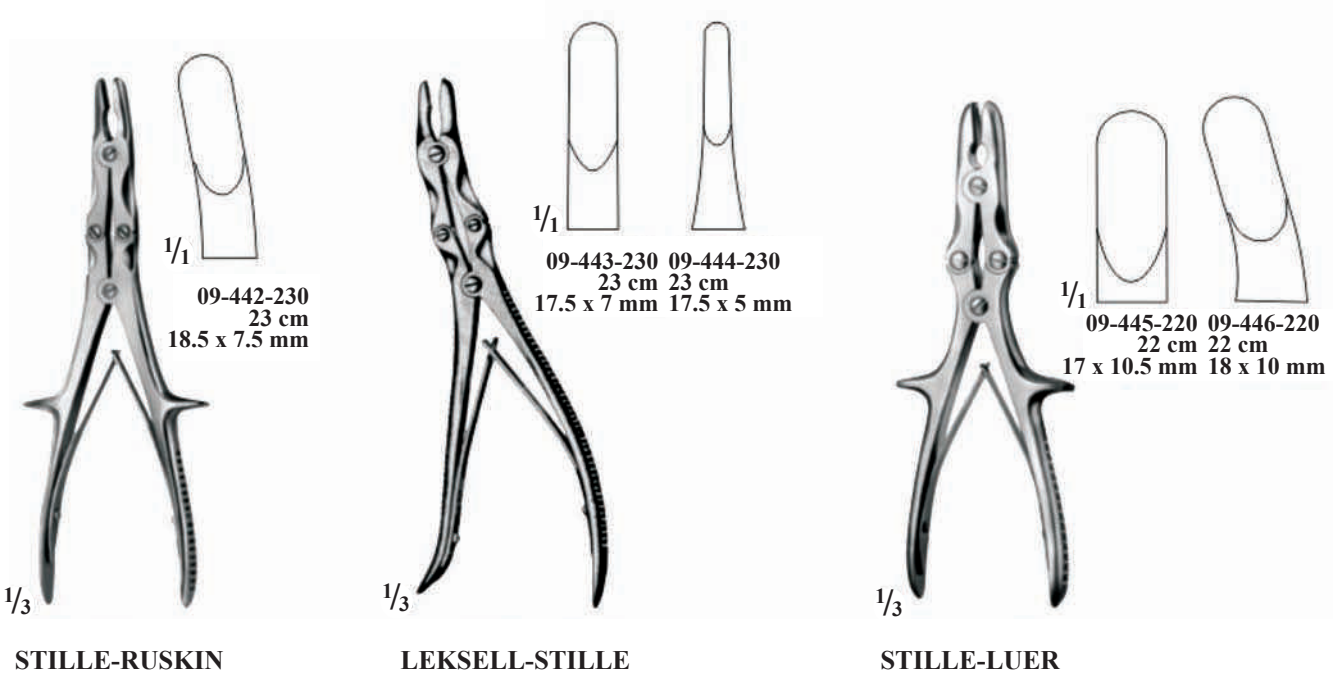

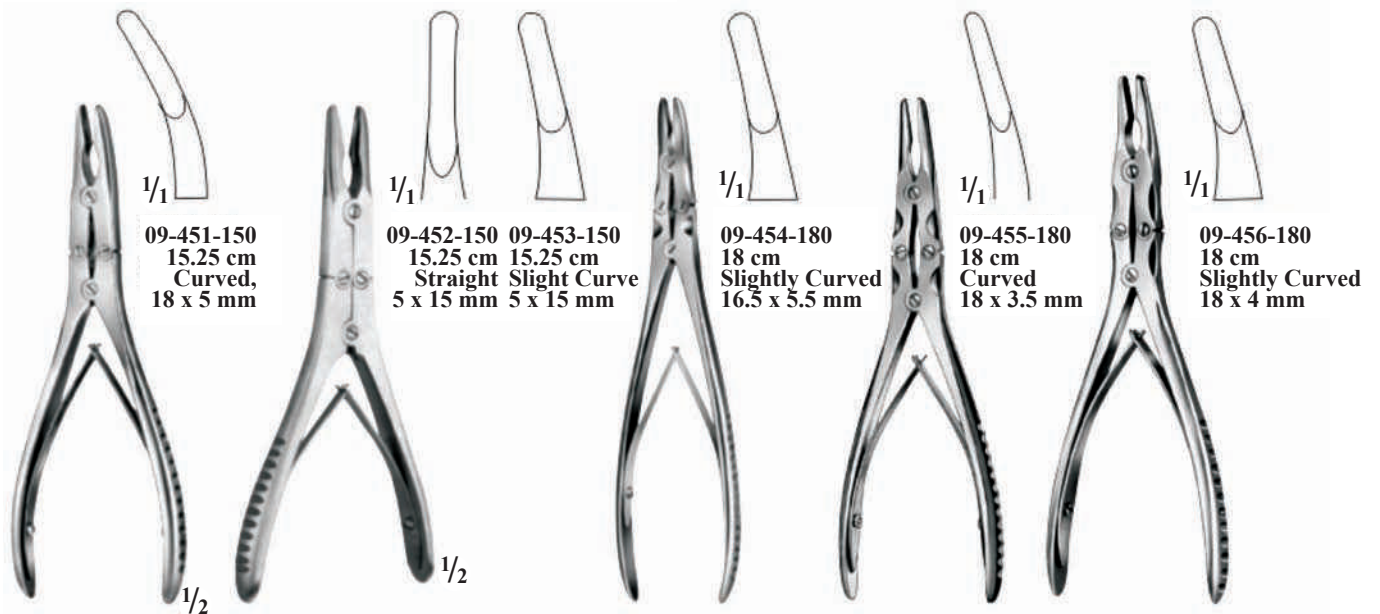

RUSKIN-MINI

BÖHLER

RUSKIN

BEYER

ZAUFAL-JANSEN

09-451-150
15.25 cm
Curved,
18 x 5 mm

09-452-150 09-453-150
15.25 cm 15.25 cm
Straight Slight Curve
5 x 15 mm 5 x 15 mm

09-454-180
18 cm
Slightly Curved
16.5 x 5.5 mm

09-455-180
18 cm
Curved
18 x 3.5 mm

09-456-180
18 cm
Slightly Curved
18 x 4 mm

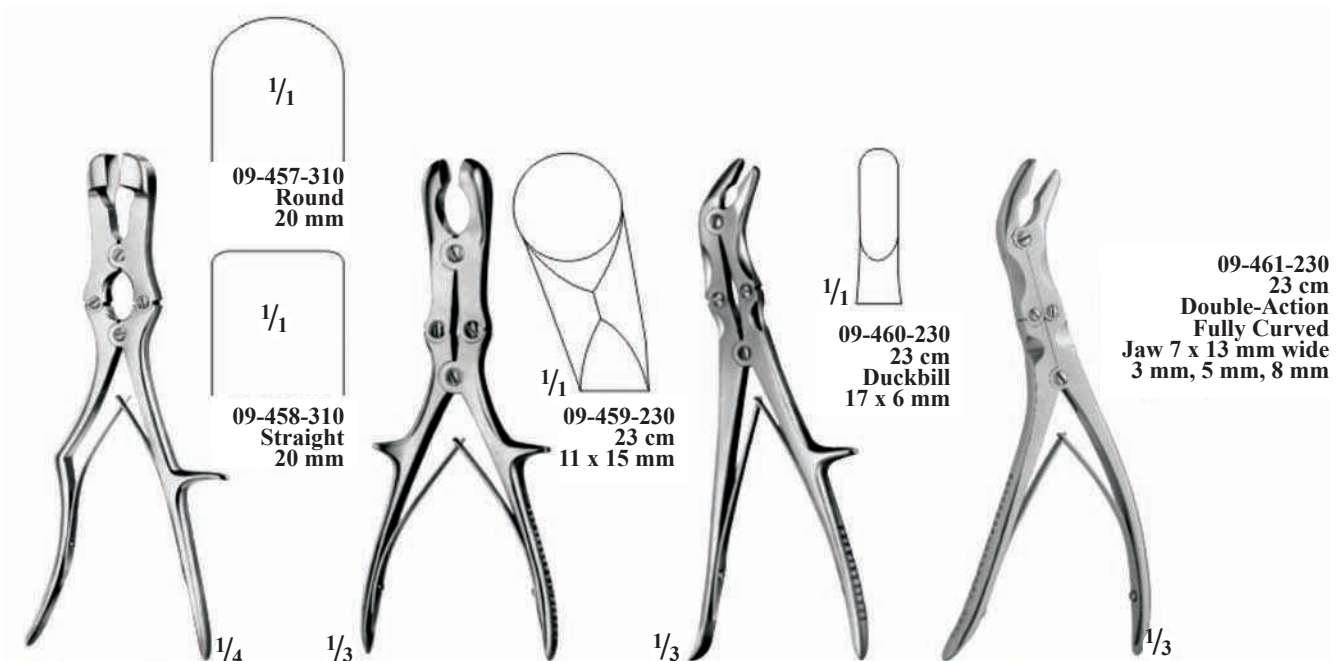

SAUERBRUCH
31 cm

SEMB

STILLE

LEKSELL

09-457-310
Round
20 mm

09-458-310
Straight
20 mm

09-459-230
23 cm
11 x 15 mm

09-460-230
23 cm
Duckbill
17 x 6 mm

09-461-230
23 cm
Double-Action
Fully Curved
Jaw 7 x 13 mm wide
3 mm, 5 mm, 8 mm

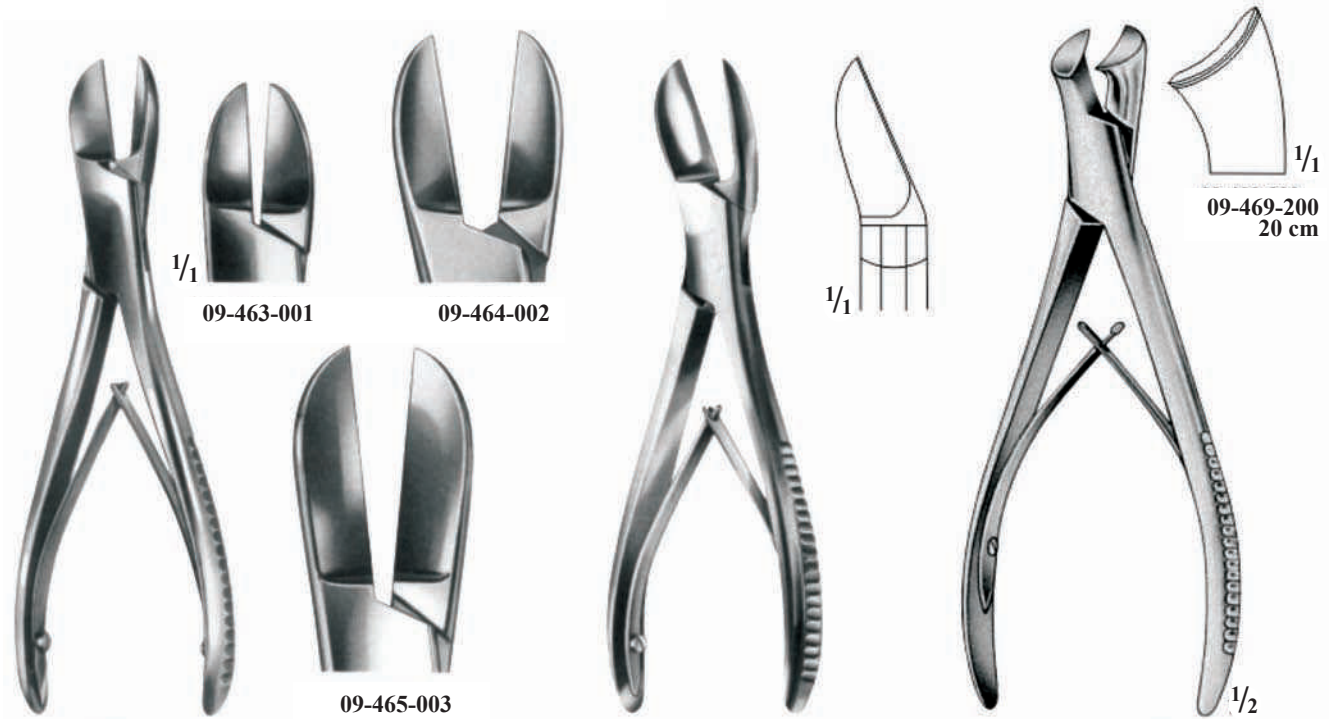

LISTON
09-462-180
18 cm

LISTON
09-466-170 17 cm
09-467-190 19 cm
09-468-220 22 cm
curved on flat

MARKWALDER

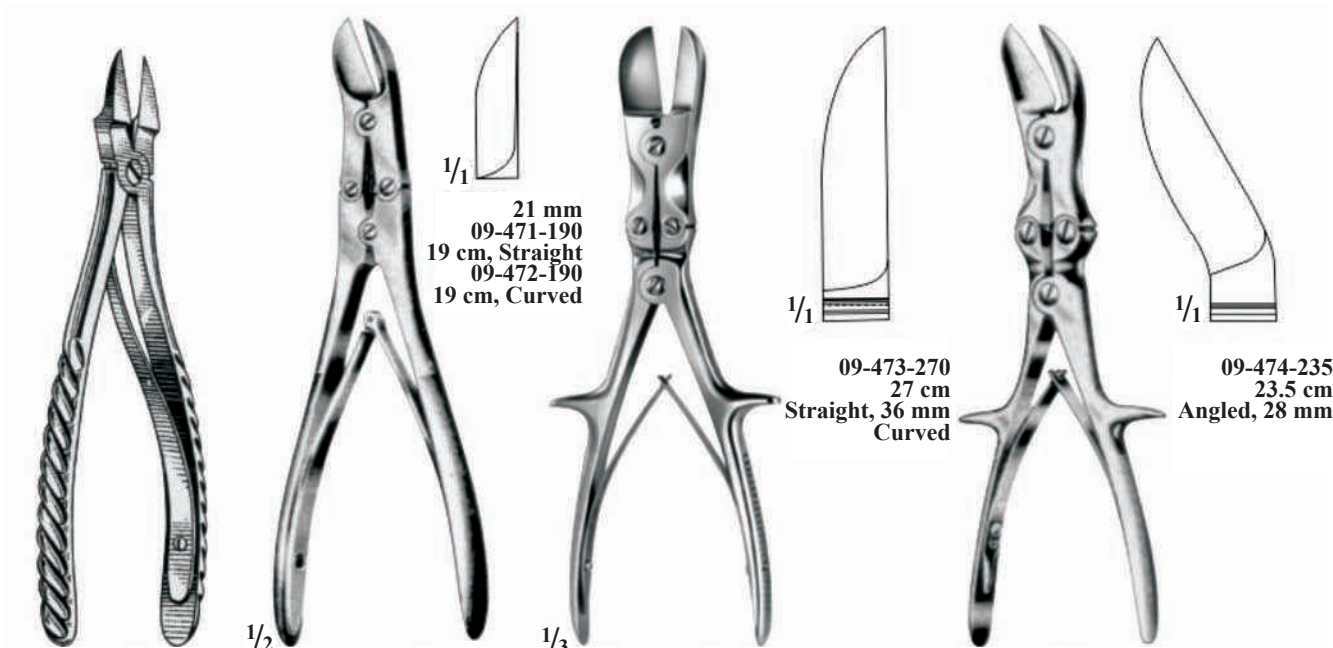

DURAY STAMM
09-470-150
15 cm

RUSKIN-LISTON

STILLE-LISTO

LISTON

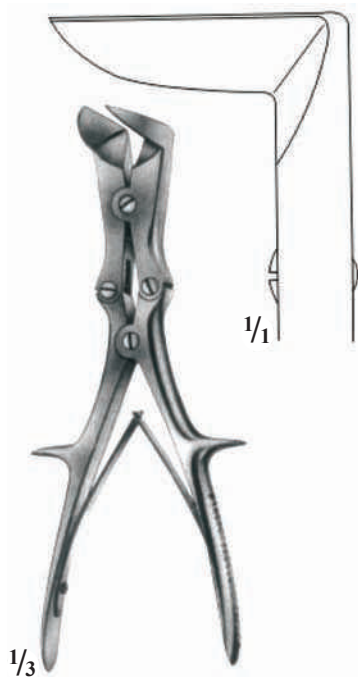

LISTON-STILLÉ
09-475-260
26 cm



McINDOE
09-476-175
17.5 cm



BOHLER
09-477-150 15 cm straight
09-478-150 15 cm curved



RUSKIN
09-479-200
20 cm



HORSLEY
09-480-250
25 cm



LISTON-KEY (HORSLEY)
09-481-270
27 cm
Angled, 28 mm



KNEE RETRACTOR
09-482-210
21 cm

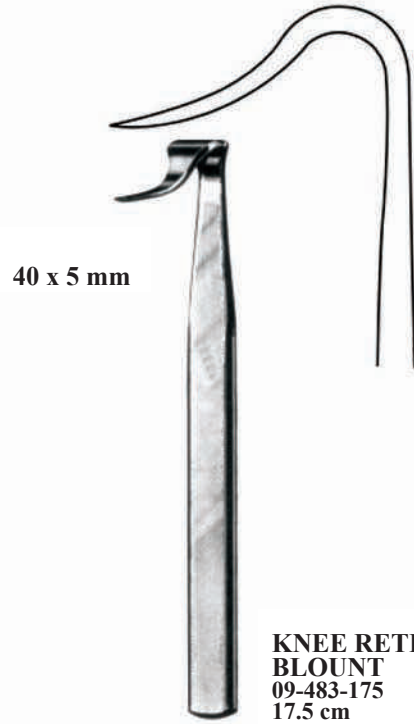

**KNEE RETRACTOR
BLOUNT**
09-483-175
17.5 cm



HERZ
09-484-230
23 cm



JAGER
09-485-235
23.5 cm

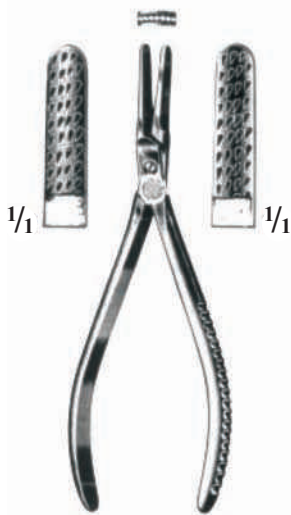

**NAIL EXTRACTING
FORCEPS**
09-486-140
14 cm

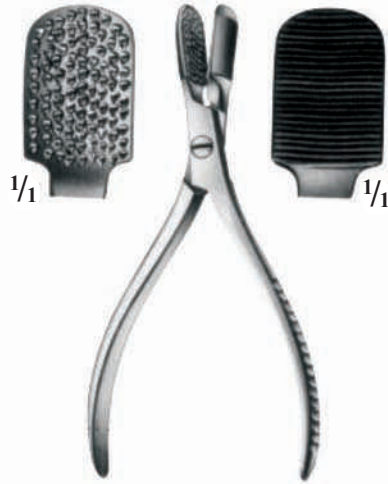

**NAIL EXTRACTING
FORCEPS**
09-487-145
14.5 cm

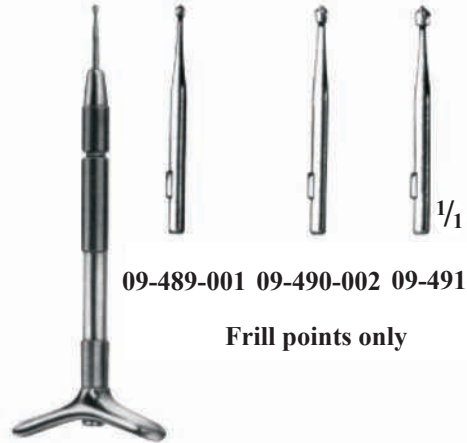

09-488-000
Finger nail drill with 3
drill points

09-489-001 09-490-002 09-491-003

Frill points only

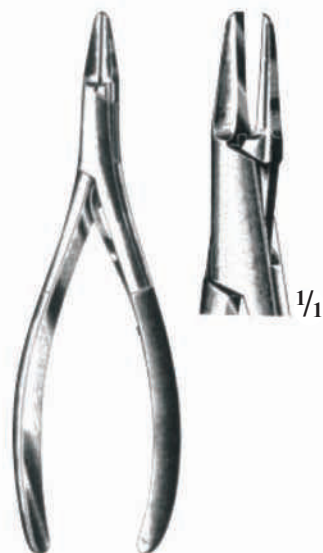

**NAIL SPLITTING
FORCEPS**
09-492-135
13.5 cm



RING CUTTER
09-493-170
17 cm



09-494-00
Saw Blade Only
for 09-493-170



RING CUTTER
09-495-170
17 cm



09-496-00
Saw Blade Only
for 09-495-170

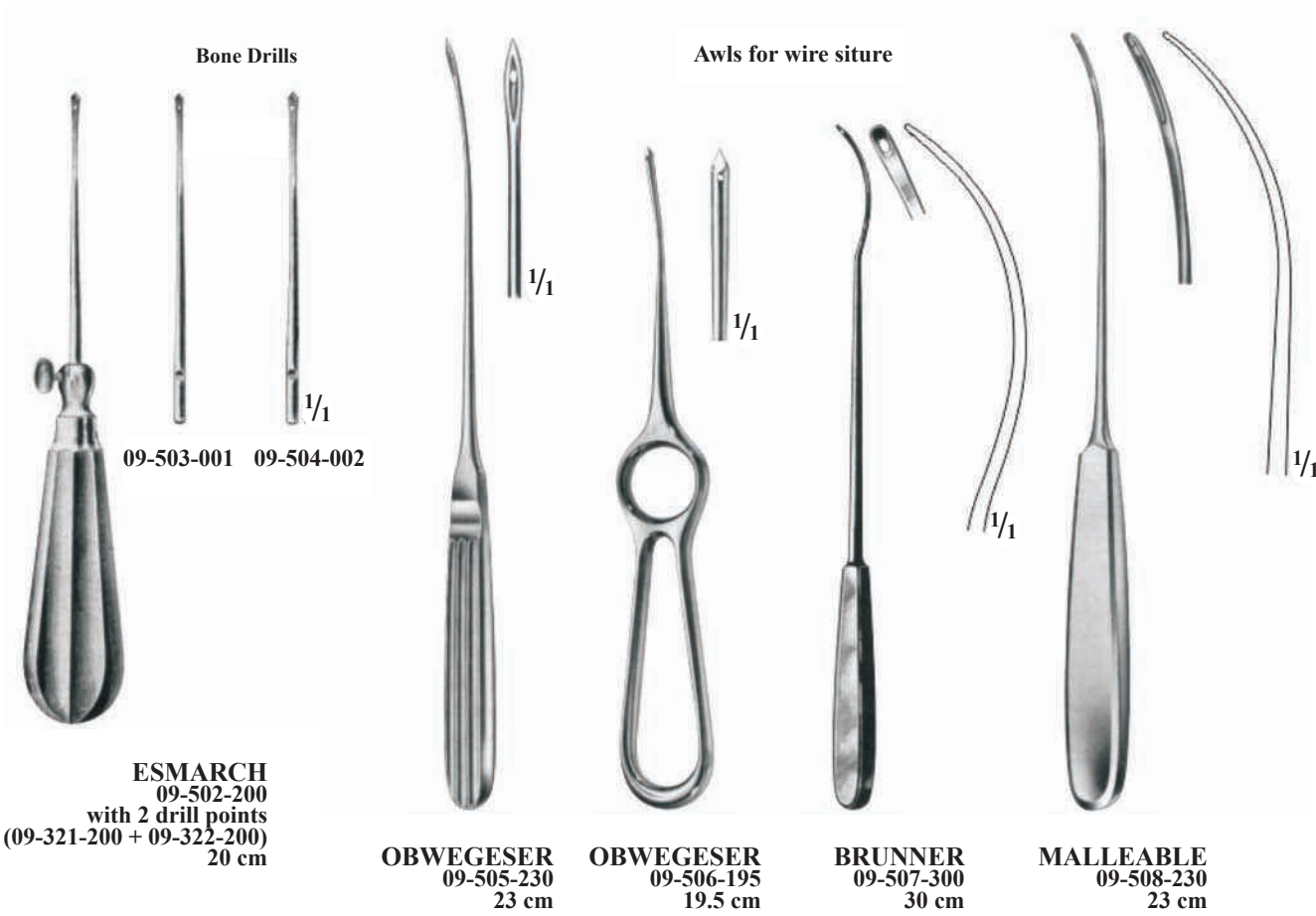
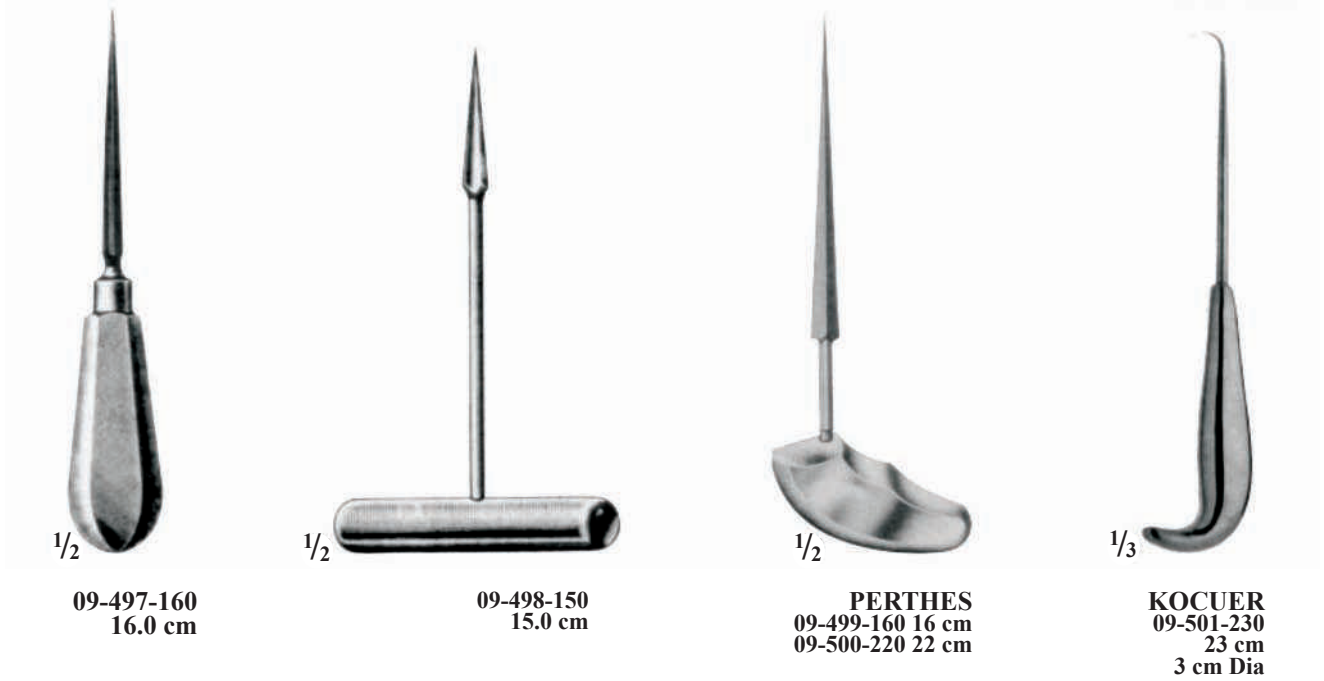



KIRSCHNER
09-509-00 40 x 140 mm
09-510-00 60 x 220 mm

KIRSCHNER, AMERICAN TYPE
09-511-130 Medium 13.0 cm
09-512-185 Large 18.5 cm
09-513-220 Extra Large 22.0 cm
Max, Jaw Opening

KIRSCHNER
09-514-00 200 x 155 mm
09-515-00 155 x 155 mm
09-516-00 135 x 130 mm
09-517-00 120 x 120 mm
09-518-00 105 x 100 mm
09-519-00 95 x 110 mm
09-520-00 95 x 70 mm

SCREW NUT WRENCH
09-521-00
14 x 17 mm



CHARNLEY-MUELLER
09-522-00
Compression Clamp

	Inside Length	Inside Width
09-523-00	90 mm	75 mm
09-524-00	160 mm	90 mm
09-525-00	210 mm	110 mm
09-526-00	210 mm	150 mm

WIRE TIGHTENING
09-527-180
18 cm

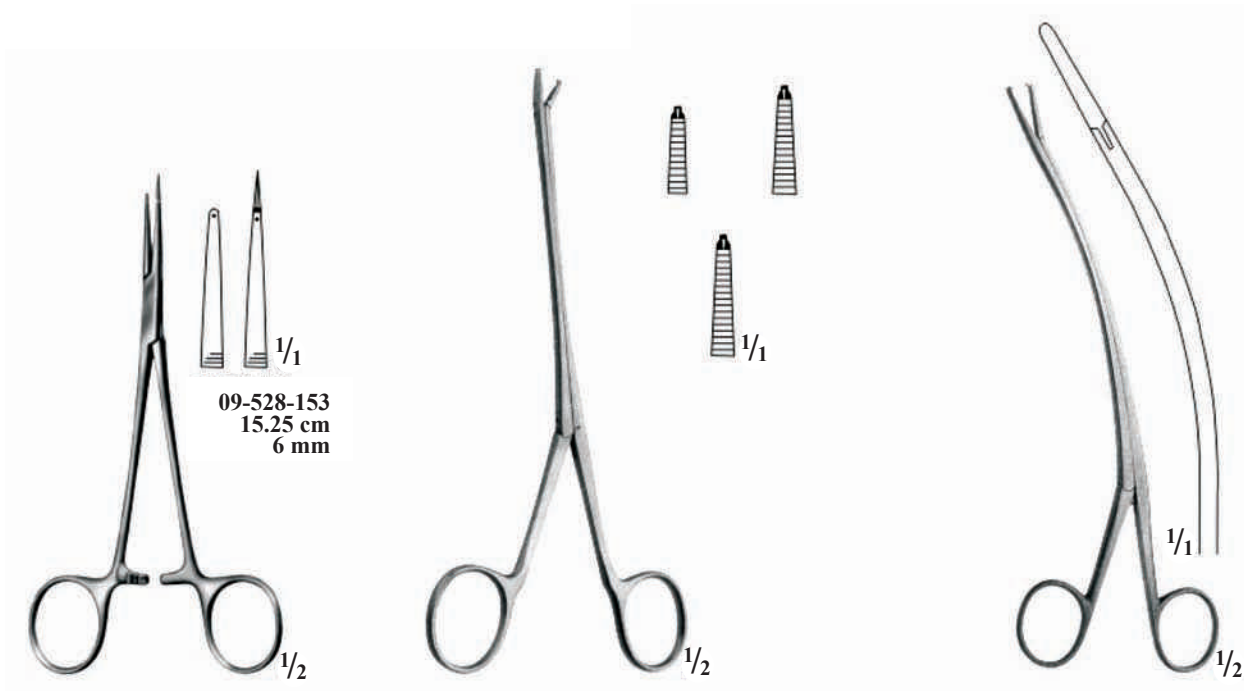

TENDON

09-528-153
15.25 cm
6 mm

BRAND
09-529-150 15 cm
09-530-190 19 cm
09-531-240 24 cm

BRAND
09-532-150 15 cm
09-533-190 19 cm
09-534-240 24 cm

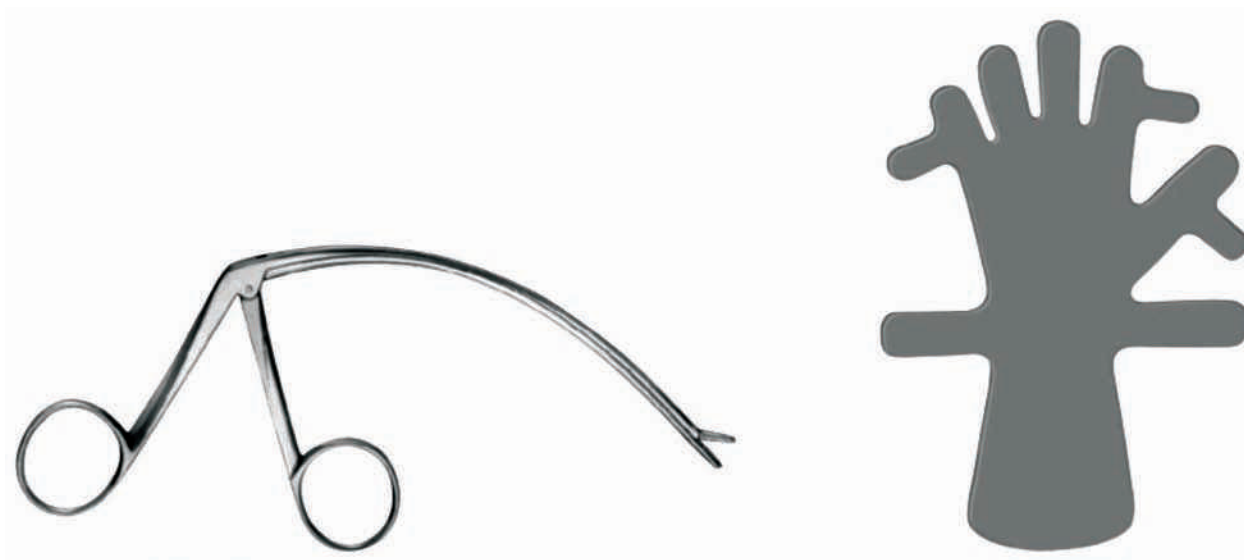

CARROLL
09-535-130
13 cm
Curved Shaft
2 x 6 mm

LEAD HAND
09-536-00
Adult Size

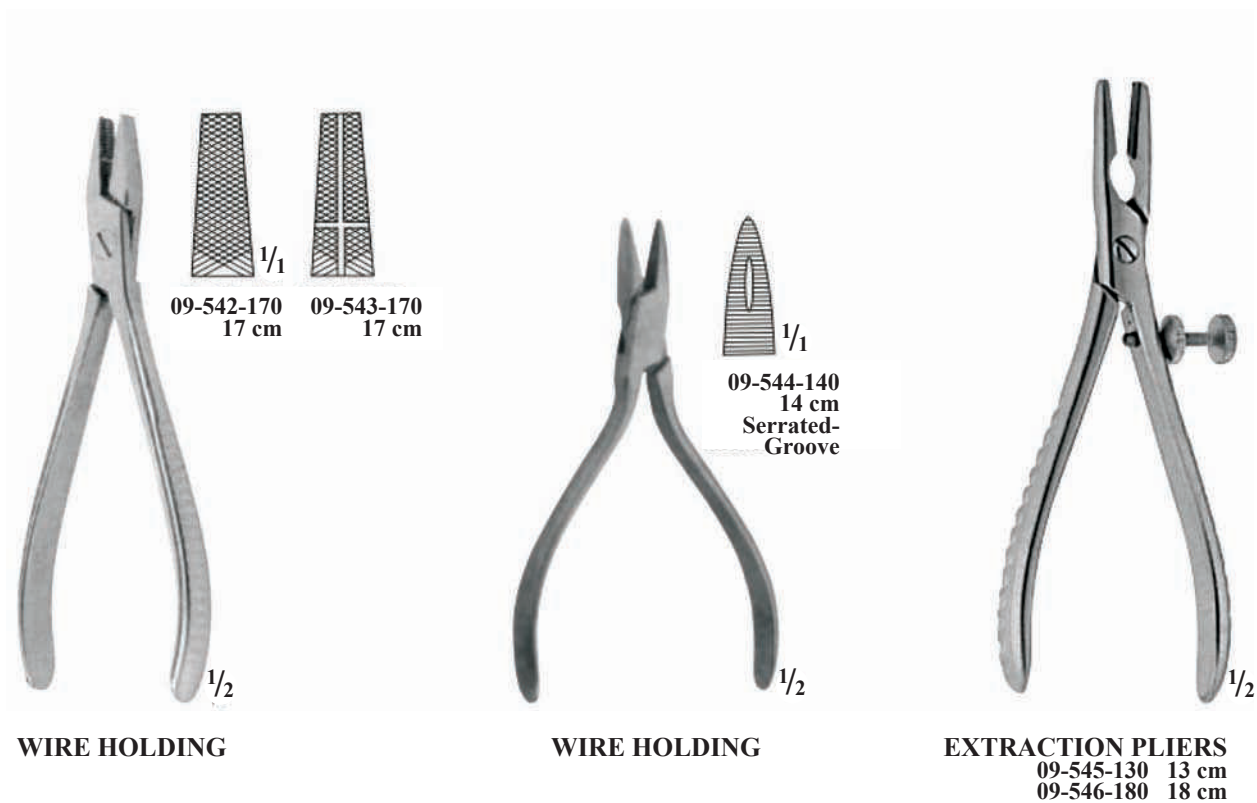



WIRE HOLDING
09-547-180 18 cm



LOCKING PLIERS

1/1
09-548-150
15 cm
With Spring
serrated



WIRE HOLDING
09-549-180 18 cm



SLIP JOINT

1/1
09-550-195
19.5 cm



09-551-150
15 cm

DIAMANT PIN CYTTER
09-552-160
16 cm

09-553-220
22 cm

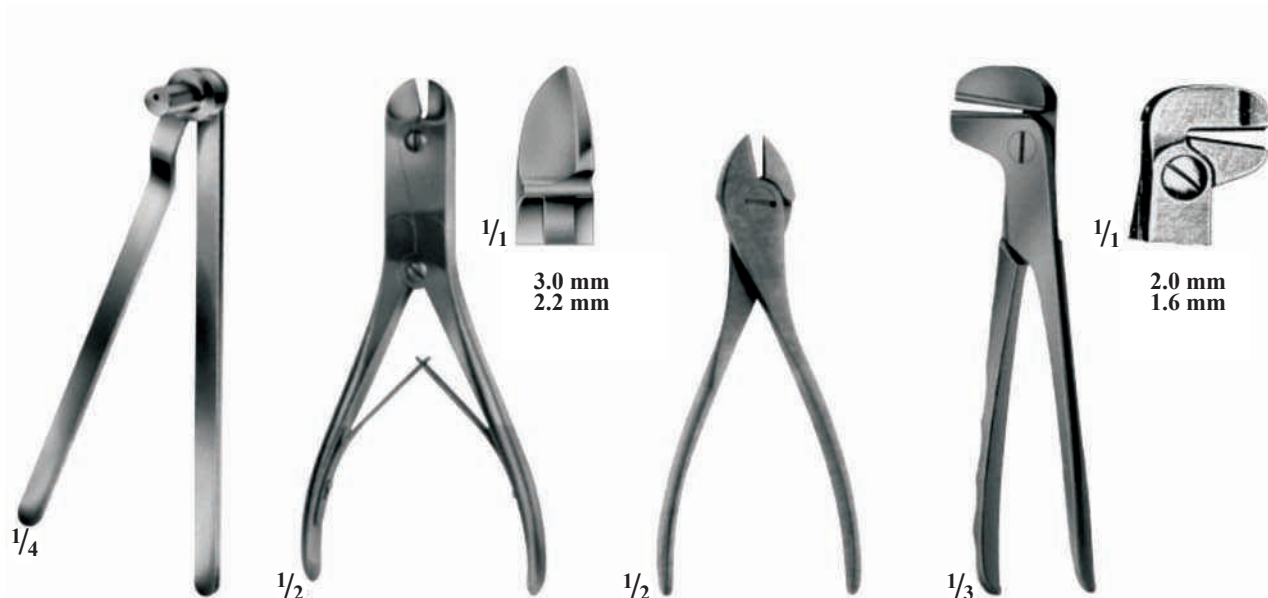

09-554-320
32 cm
3.0 mm, 3.0 mm

09-555-235
23.5 cm

09-556-140
14 cm
1.2 mm

09-557-240
24 cm



GIGLI SAW
09-558-030 30 mm
09-559-040 40 mm
09-560-050 50 mm
09-561-070 70 mm
stainless

GIGLI HANDLE
09-562-00

**ENGEL
PLASTER SAW**
09-563-155
15.5 cm

CHARRIERE
09-564-250 25 cm
09-565-270 27 cm
Double saw

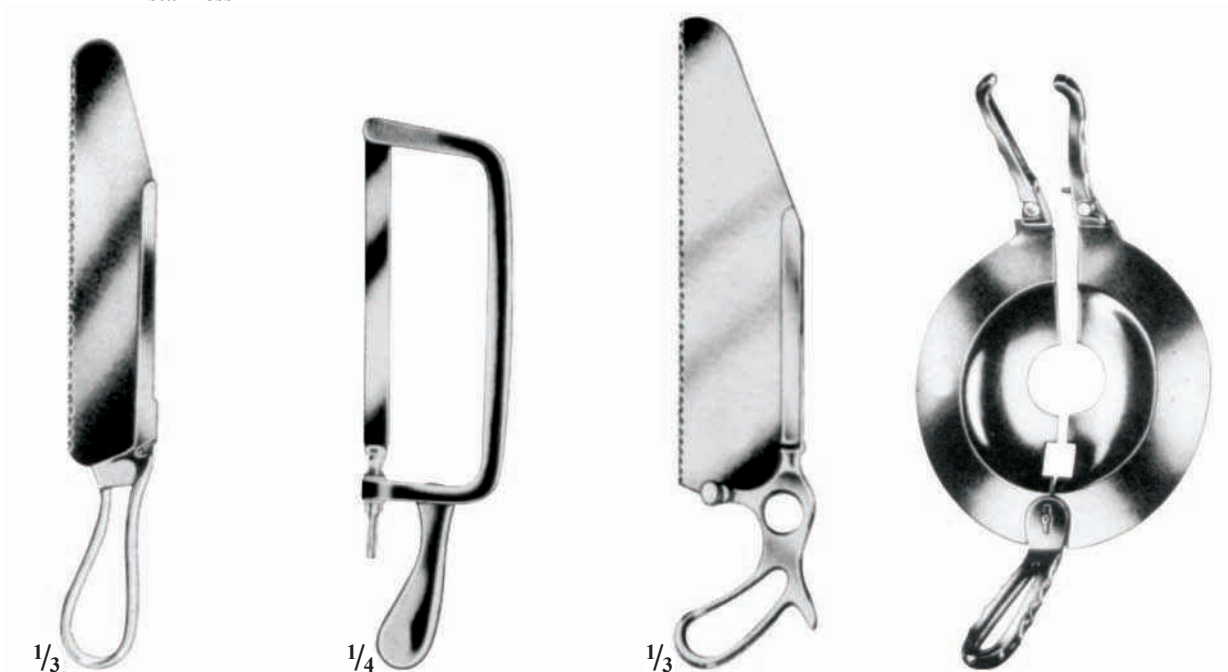

CHARRIERE
09-566-270 27 cm
09-567-300 30 cm

CHARRIERE
09-568-350
35 cm

SATTERLEE
09-569-310
31 cm

PERCY RETRACTOR
09-570-00

**Plaster shears / spreader –
инструмент для снятия гипсовых повязок**



PLASTER-BRUNS
09-571-240
24 cm
Saw Edge

SEUTIN
09-572-230
23.0 cm

BOHLER
09-573-180 18 cm
09-574-240 24 cm



1/2

STILLE
09-575-200 20 cm
09-576-230 23 cm
09-577-260 26 cm
09-578-370 37 cm

1/2

HENNIG
09-579-280
28 cm

1/1

09-580-230
23 cm
3 Progn

MODEL USA



KEY
With Fiber
09-581-180
Handle 18 cm

SCREW DRIVER
09-582-00
slotted head

SCREW DRIVER
09-583-00
philips head

SCREW DRIVER
09-584-00
single head



**BONE SCREW
HOLDING FORCEPS**
09-585-00
Bone Screw

**BONE PLATE
HOLDING FORCEPS**
09-586-00
Bone Plate

BENDING PLIERS
09-587-00
2.7 mm & 3.5 mm
Plates

T.C. Flat nose pliers & wire cutting pliers – плоскогубцы армированные твердым сплавом



EXTRACTION PLIERS
09-588-180 18 cm
09-589-180 18 cm

EXTRACTION PLIERS
09-590-200 20 cm

EXTRACTION PLIERS
09-591-200 20 cm

EXTRACTION PLIERS



WIRE CUTTERS
09-594-180 18 cm

WIRE CUTTERS
09-595-180 18 cm
09-596-210 21 cm

WIRE CUTTERS
09-597-180 18 cm

**T.C. Wire cutting pliers – щипцы
и кусачки – армированные твердым сплавом**



UNIVERSAL SCISSORS
09-598-100 10 cm
09-599-120 12 cm



WIRE CUTTER
09-600-180 18 cm ^{1/2}



WIRE CUTTERS
09-601-180 18 cm ^{3/4}



^{1/4} **WIRE CUTTERS**
09-602-460 46 cm
09-603-560 56 cm



WIRE CUTTERS
09-604-180 18 cm
09-605-220 22 cm ^{1/2}



^{1/1}
2.0 mm
1.6 mm



09-606-240 24 cm ^{1/2}