

SECTION – 11

Neurosurgery *нейрохирургия*





11-001-00
wire cable only



11-002-00
Support only,
flat brain spatulas

11-003-00
Support only,
flat brain spatulas
with round shaft
up to 5.5 mm diam.
Fixing for flexible

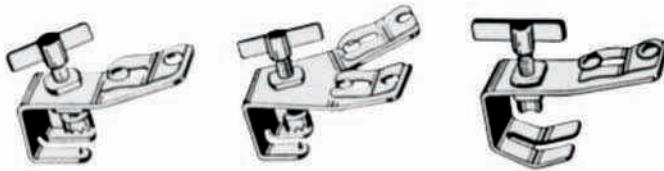

11-004-00
RIECHERT
Fixation base, for skull
mounting, holding 1
flexible arms

11-005-00
RIECHERT
Fixation base, for skull
mounting, holding 2
flexible arms

11-006-00
RIECHERT
Fixation base, for skull
mounting, holding 1
flexible arms



LEYLA
Self-Retaining Brain Retractor
with 1 flexible arms, complete consisting of
11-007-00
11-008-00
11-009-00

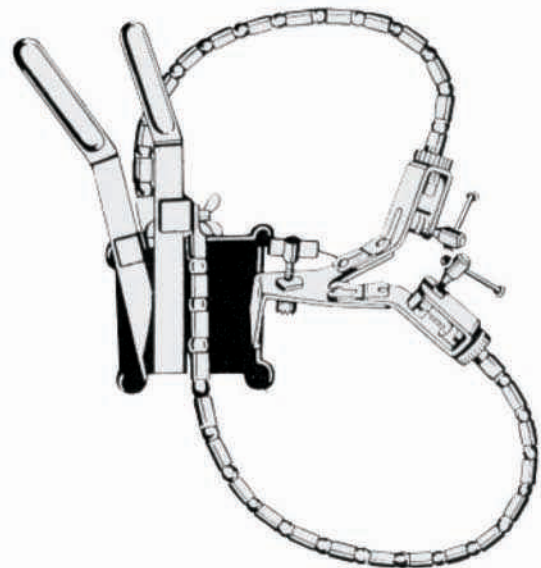

LEYLA
Self-Retaining Brain Retractor
with 2 flexible arms, complete consisting of
11-010-00
11-011-00
11-012-00

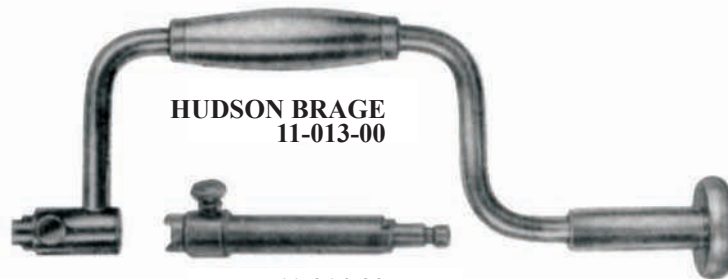

HUDSON BRAGE
11-013-00

11-014-00
Cerebellar Extension Only

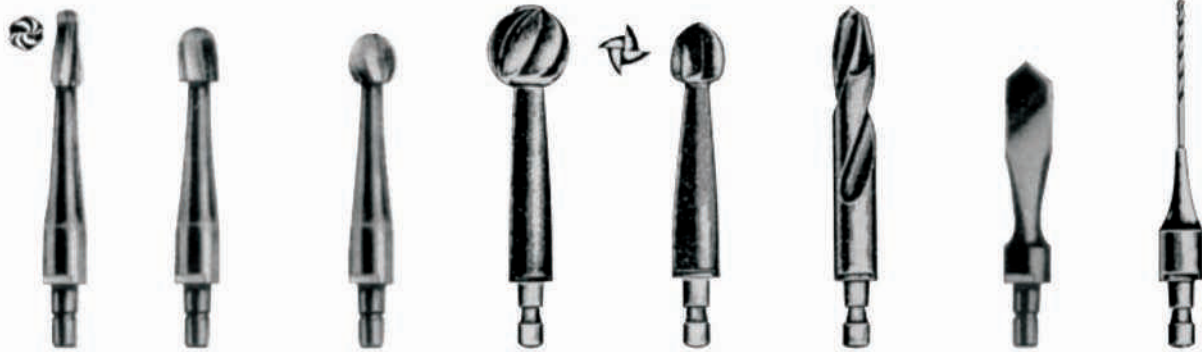

HUDSON
11-015-00
Ø 9 mm

HUDSON
11-016-00
Ø 14 mm

HUDSON
11-017-00
Ø 16 mm

HUDSON
11-018-00
Ø 22 mm

ADSON
11-019-00
Ø 15 mm

Mc KENZIE
11-020-00
Ø 13 mm

CUSHING
11-021-00
Ø 14 mm

11-022-00
Ø 2 mm



GALT
11-023-00 Ø 12.5 mm
11-024-00 Ø 18 mm
11-025-00 Ø 19 mm



CRUTCHFIELD
11-026-00
Small size

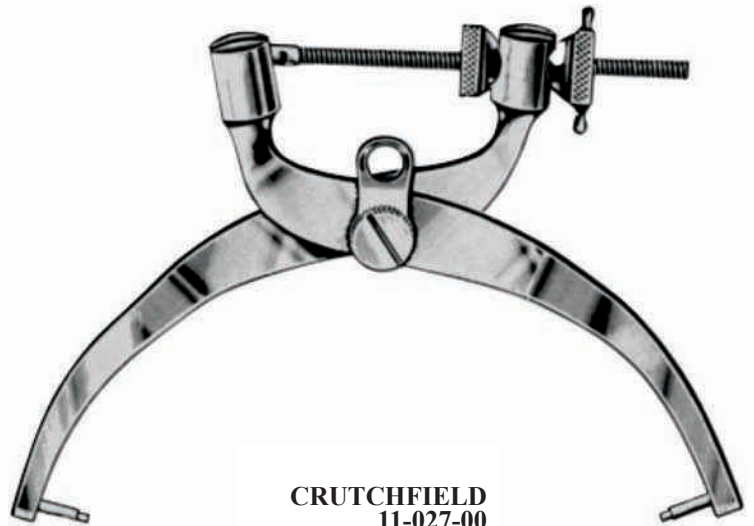

CRUTCHFIELD
11-027-00
medium size



11-028-00
11-029-00
Drill points

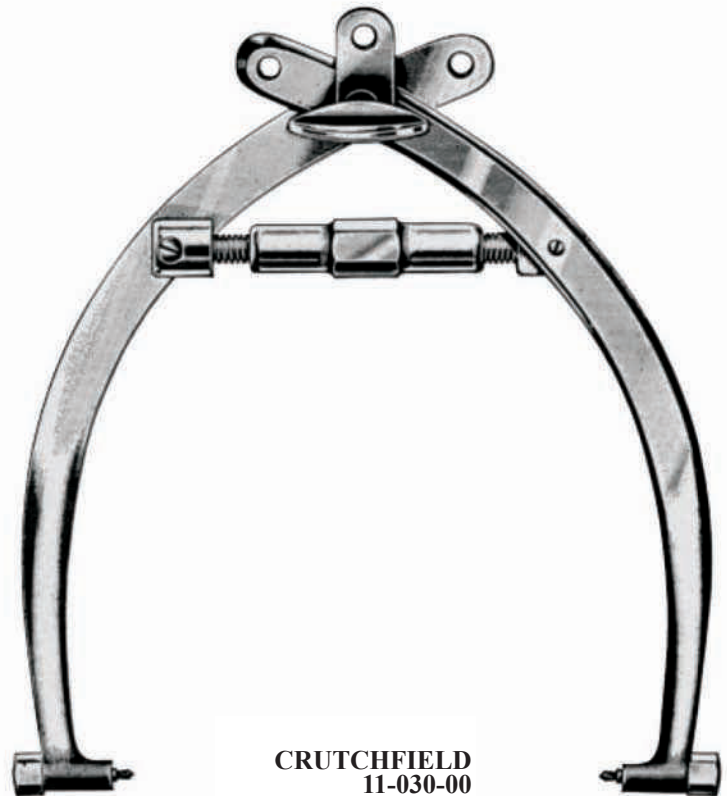

CRUTCHFIELD
11-030-00
large size

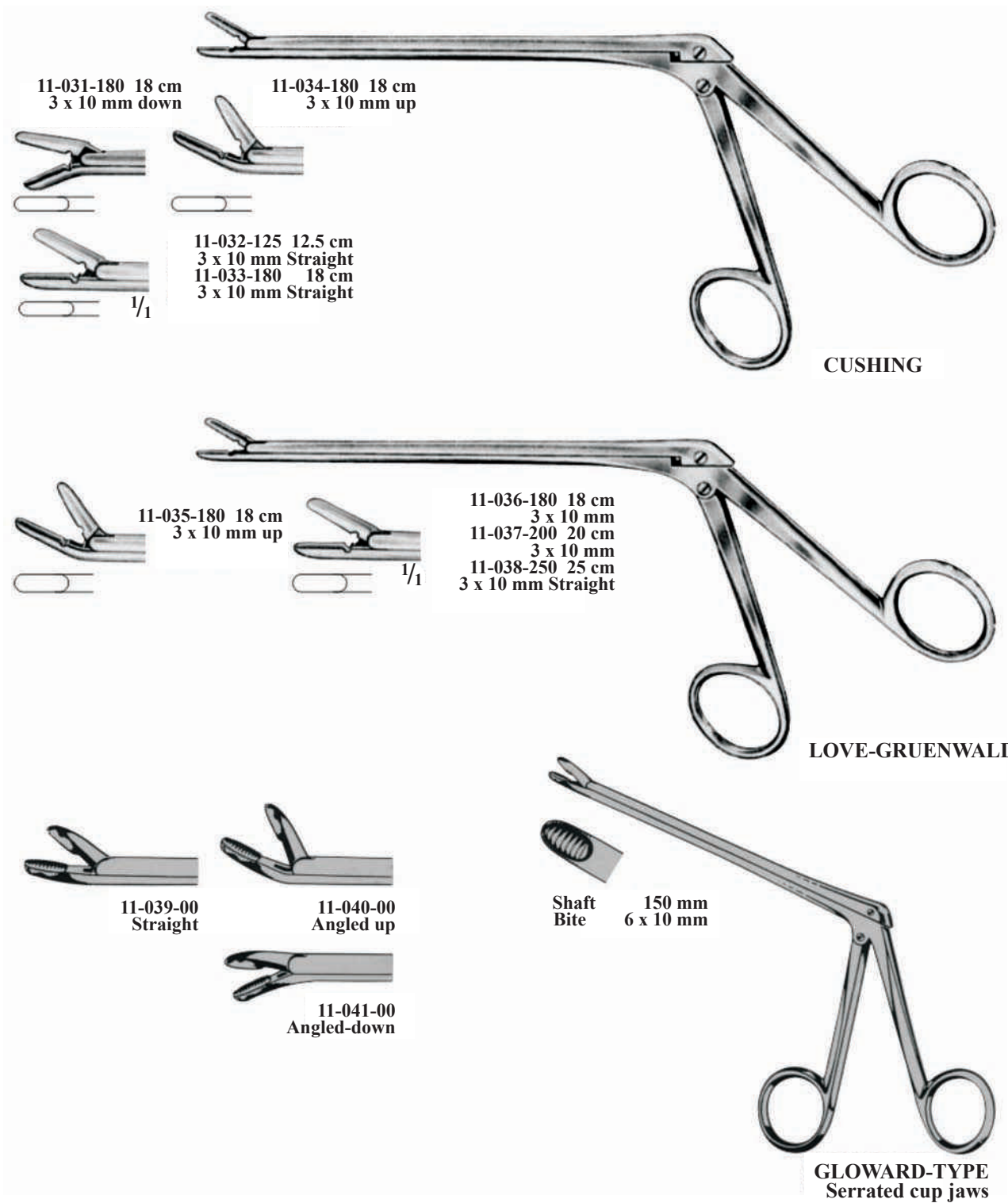



SPURLING

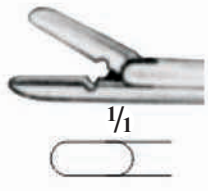

11-042-150 15 cm
4 x 10 mm
11-043-180 18 cm
4 x 10 mm
11-044-200 20 cm
4 x 10 mm Straight

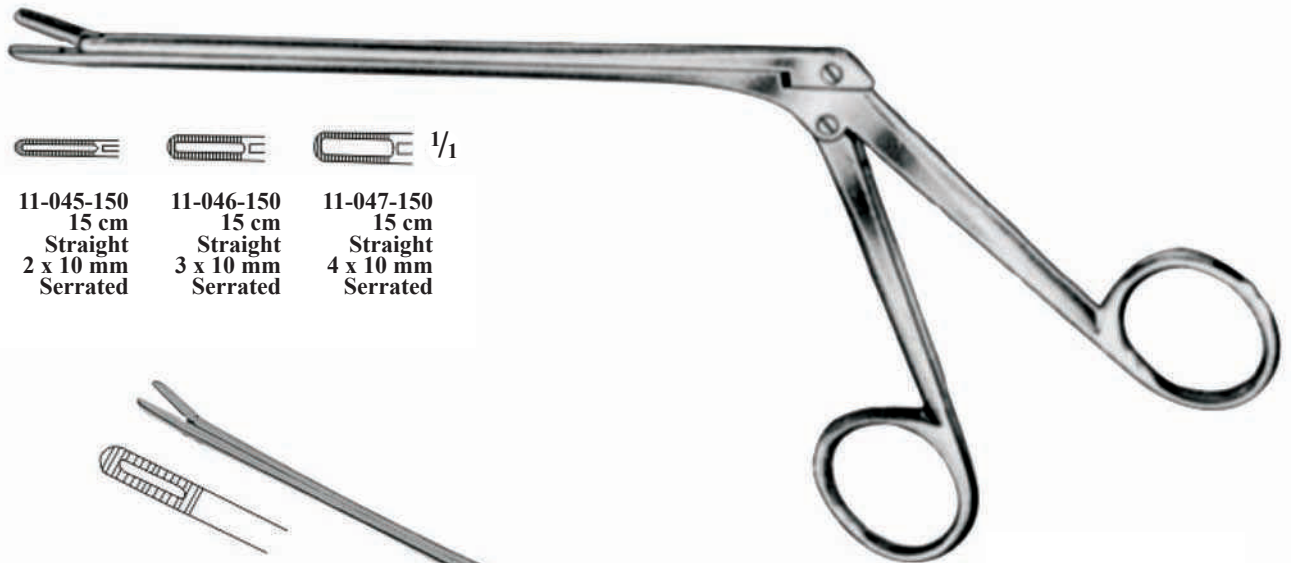

SCHLESINGER



11-045-150 15 cm
Straight
2 x 10 mm
Serrated

11-046-150 15 cm
Straight
3 x 10 mm
Serrated

11-047-150 15 cm
Straight
4 x 10 mm
Serrated



Straight

Shaft	130 mm	150 mm	180 mm
Bite 2 x 10 mm	11-048-00	11-051-00	11-054-00
Bite 3 x 10 mm	11-049-00	11-052-00	11-055-00
Bite 4 x 10 mm	11-050-00	11-053-00	11-056-00



SCHLESINGER

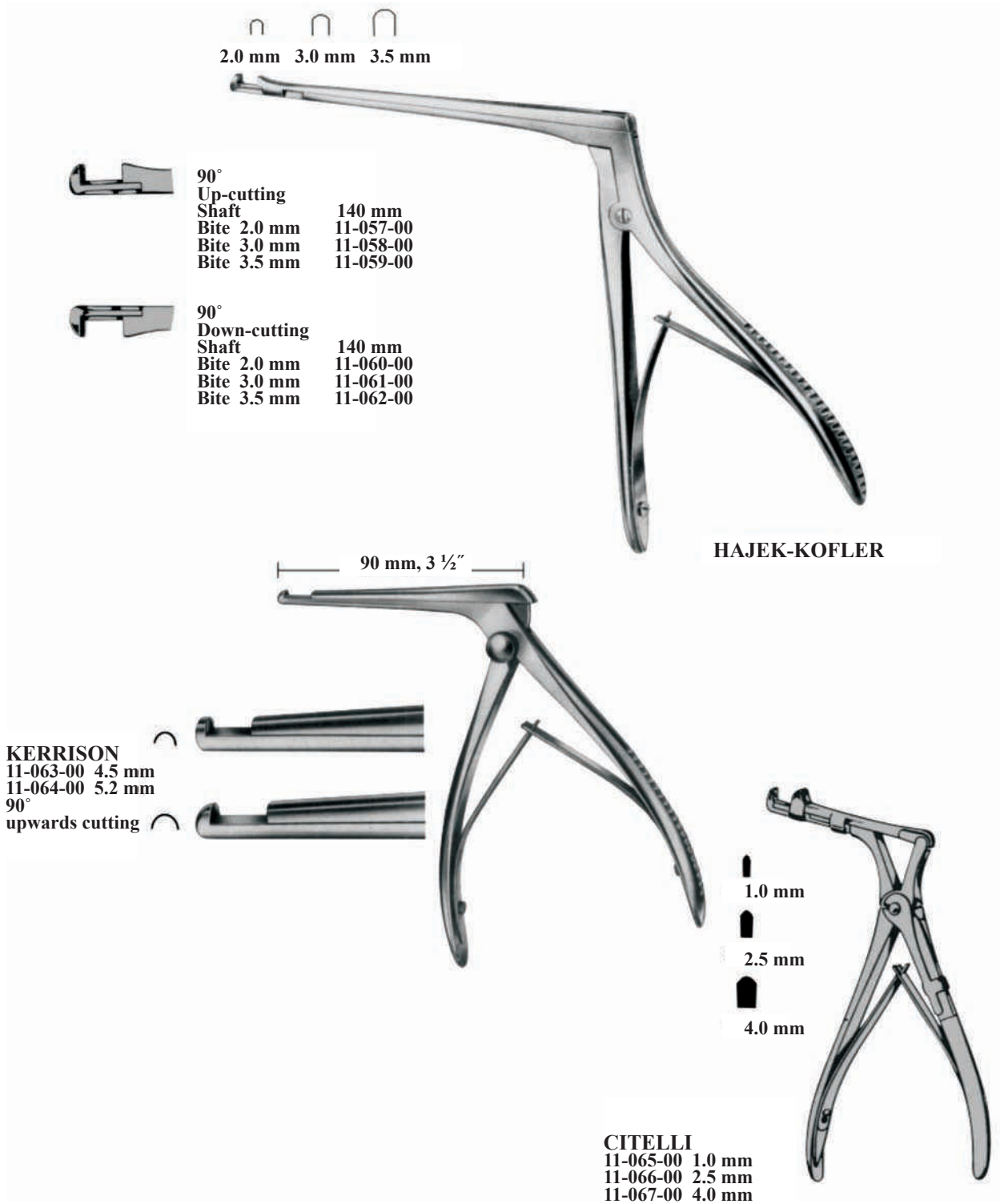



**LOVE-KERRISON
LAMINECTOMY PUNCH**



Forward 90° Regular Footplate

□ 2 mm bite forward
11-068-00 150 mm
11-069-00 200 mm

□ 3 mm bite forward
11-070-00 150 mm
11-071-00 200 mm

□ 4 mm bite forward
11-072-00 150 mm
11-073-00 200 mm

□ 5 mm bite forward
11-074-00 150 mm
11-075-00 200 mm

□ 6 mm bite forward
11-076-00 150 mm
11-077-00 200 mm



Forward 40° Regular Footplate

□ 2 mm bite up
11-078-00 150 mm
11-079-00 200 mm

□ 3 mm bite up
11-080-00 150 mm
11-081-00 200 mm

□ 4 mm bite up
11-082-00 150 mm
11-083-00 200 mm

□ 5 mm bite up
11-084-00 150 mm
11-085-00 200 mm

□ 6 mm bite up
11-086-00 200 mm



Forward 90° Regular Footplate

□ 3 mm bite down
11-087-00 150 mm
11-088-00 200 mm

□ 4 mm bite down
11-089-00 150 mm
11-090-00 200 mm

□ 5 mm bite down
11-091-00 150 mm
11-092-00 200 mm



KERRISON PUNCH



Forward 90°

□	1 mm bite forward	
	11-093-00	150 mm
	11-094-00	180 mm
	11-095-00	200 mm

□	2 mm bite forward	
	11-096-00	150 mm
	11-097-00	180 mm
	11-098-00	200 mm

□	3 mm bite forward	
	11-099-00	150 mm
	11-100-00	180 mm
	11-101-00	200 mm

□	4 mm bite forward	
	11-102-00	150 mm
	11-103-00	180 mm
	11-104-00	200 mm

□	5 mm bite forward	
	11-105-00	150 mm
	11-106-00	180 mm
	11-107-00	200 mm



Up 40°

□	1 mm bite up	
	11-108-00	180 mm

□	2 mm bite up	
	11-109-00	180 mm

□	3 mm bite up	
	11-110-00	180 mm

□	4 mm bite up	
	11-111-00	180 mm

□	5 mm bite up	
	11-112-00	180 mm



Down 90°

□	1 mm bite down	
	11-113-00	180 mm

□	2 mm bite down	
	11-114-00	180 mm

□	3 mm bite down	
	11-115-00	180 mm

□	4 mm bite down	
	11-116-00	180 mm

□	5 mm bite down	
	11-117-00	180 mm

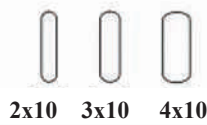

2x10 3x10 4x10



**CUSHING
LOVE - GRUENWALD
SPURLING**



Straight

Shaft	130 mm	180 mm
Bite 2x10 mm	11-118-00	11-121-00
Bite 3x10 mm	11-119-00	11-122-00
Bite 4x10 mm	11-120-00	11-123-00



Angled - up

Shaft	130 mm	180 mm
Bite 2x10 mm	11-124-00	11-127-00
Bite 3x10 mm	11-125-00	11-128-00
Bite 4x10 mm	11-126-00	11-129-00



Angled - down

Shaft	130 mm	180 mm
Bite 2x10 mm	11-130-00	11-133-00
Bite 3x10 mm	11-131-00	11-134-00
Bite 4x10 mm	11-132-00	11-135-00

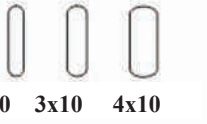

2x10 3x10 4x10

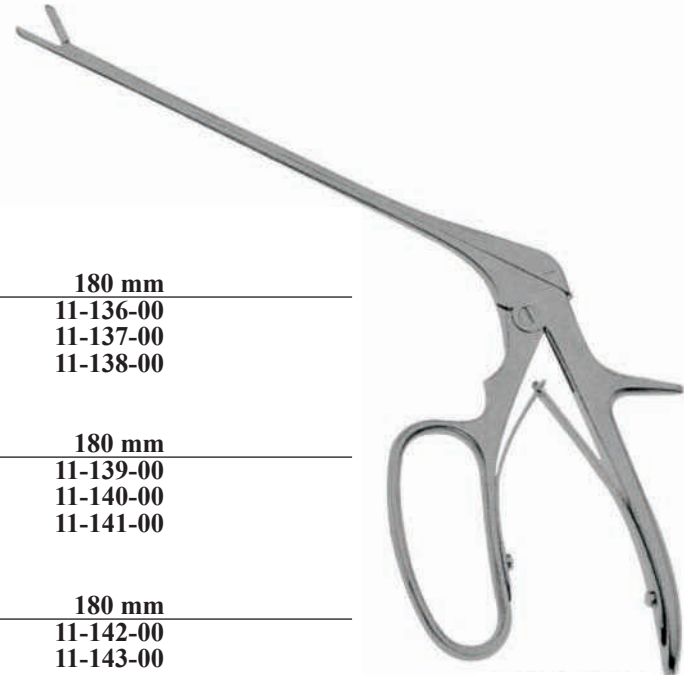

FERRIS - SMITH



Straight

Shaft	180 mm
Bite 2x10 mm	11-136-00
Bite 3x10 mm	11-137-00
Bite 4x10 mm	11-138-00



Angled - up

Shaft	180 mm
Bite 2x10 mm	11-139-00
Bite 3x10 mm	11-140-00
Bite 4x10 mm	11-141-00



Angled - down

Shaft	180 mm
Bite 2x10 mm	11-142-00
Bite 3x10 mm	11-143-00
Bite 4x10 mm	11-144-00

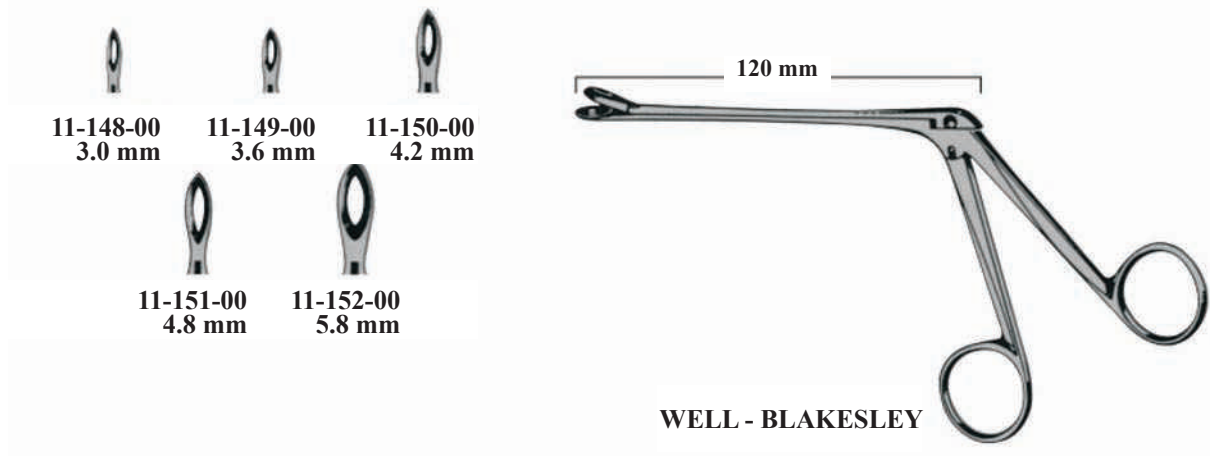
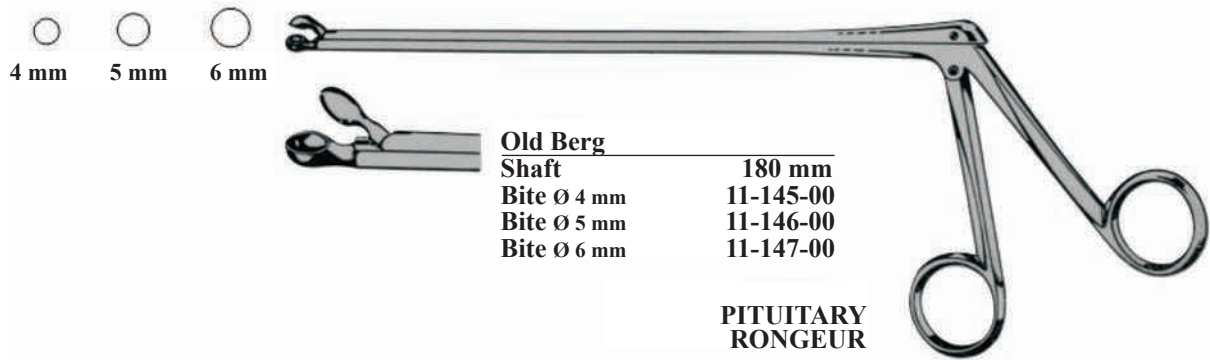



Working length 14 mm



MICRO GRASPING
11-153-00
serrated, straight



MICRO ALLIGATOR
11-154-00
straight



11-155-00
Ø 1.0 mm
straight



11-156-00
Ø 2.0 mm
straight



11-157-00
Ø 3.0 mm
straight



**MICRO CUP
FORCEPS**



11-158-00
Ø 1.0 mm
angled up



11-159-00
Ø 2.0 mm
curved to right



11-160-00
Ø 3.0 mm
curved to left



11-161-180
Ø 3 mm
Grasping Forceps



11-162-180
Ø 2.0 mm
Cup Forceps



11-163-180
Ø 2.0 mm
Alligator Scissors



**MICRO ALLIGATOR
FORCEPS**
with tubular shaft 18 cm

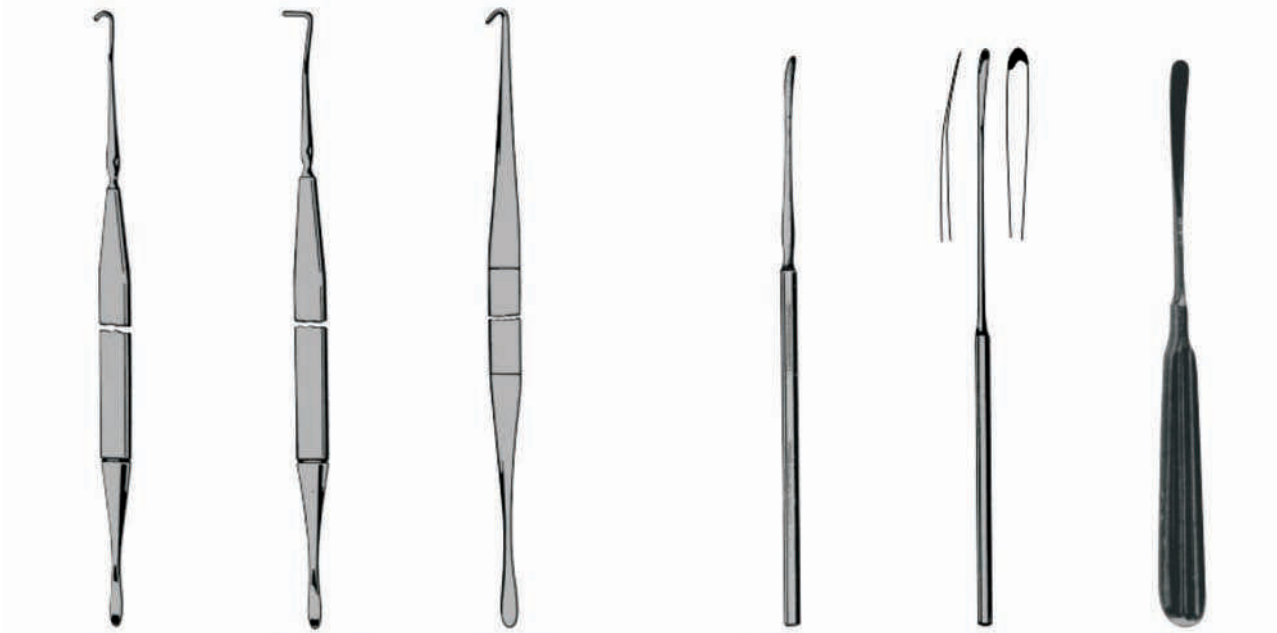

SCOVILLE
11-164-300
30 cm

SCOVILLE
11-165-300
30 cm

SCOVILLE
11-166-300
30 cm

DEVIS
11-167-190
4 mm, 19 cm

SACHS
11-168-200
3 mm, 20 cm

SACHS
11-169-200
6 mm, 20 cm

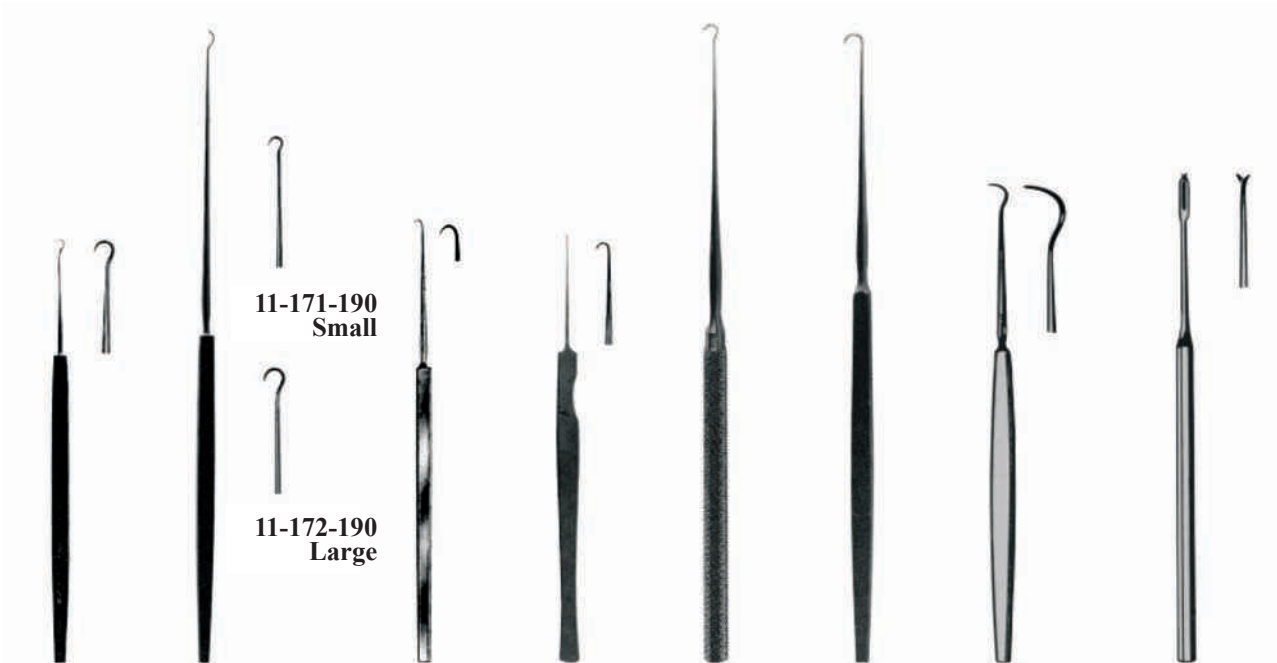

11-171-190
Small

11-172-190
Large

SCOVILLE
11-170-125
12.5 cm

GILLIES
19 cm

11-173-130
13 cm

LAHEY CLINIC
11-174-130
13 cm

SACHS
11-175-185
18.5 cm

11-176-160
16 cm

TOENNIS
11-177-150
15 cm

**DURA
TWIST HOOK**
11-178-140 14 cm

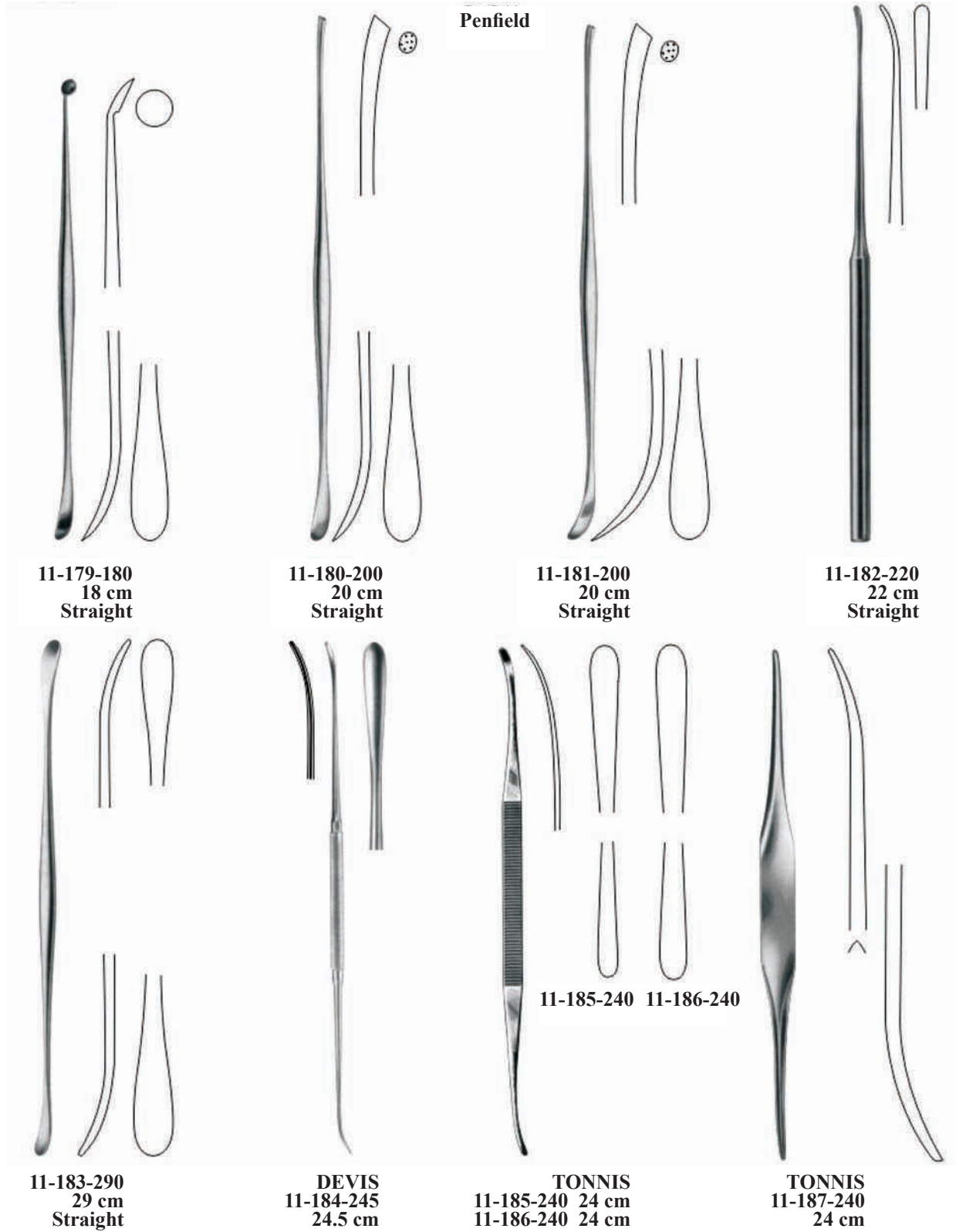

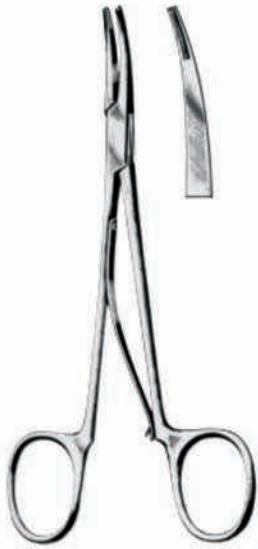

Mc KENZIE
11-188-150
15 cm



Mc KENZIE
11-189-180
18 cm



RANEY
11-190-160
16 cm



ADSON
11-191-150
15 cm
Drill Guide and
Dura Protector



CONE
11-192-200 20 cm
11-193-230 23 cm
Skull Punch

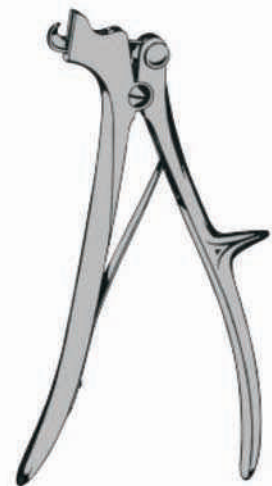

DEVIBISS
11-194-210 21 cm
complete with 1 small and
1 large blade

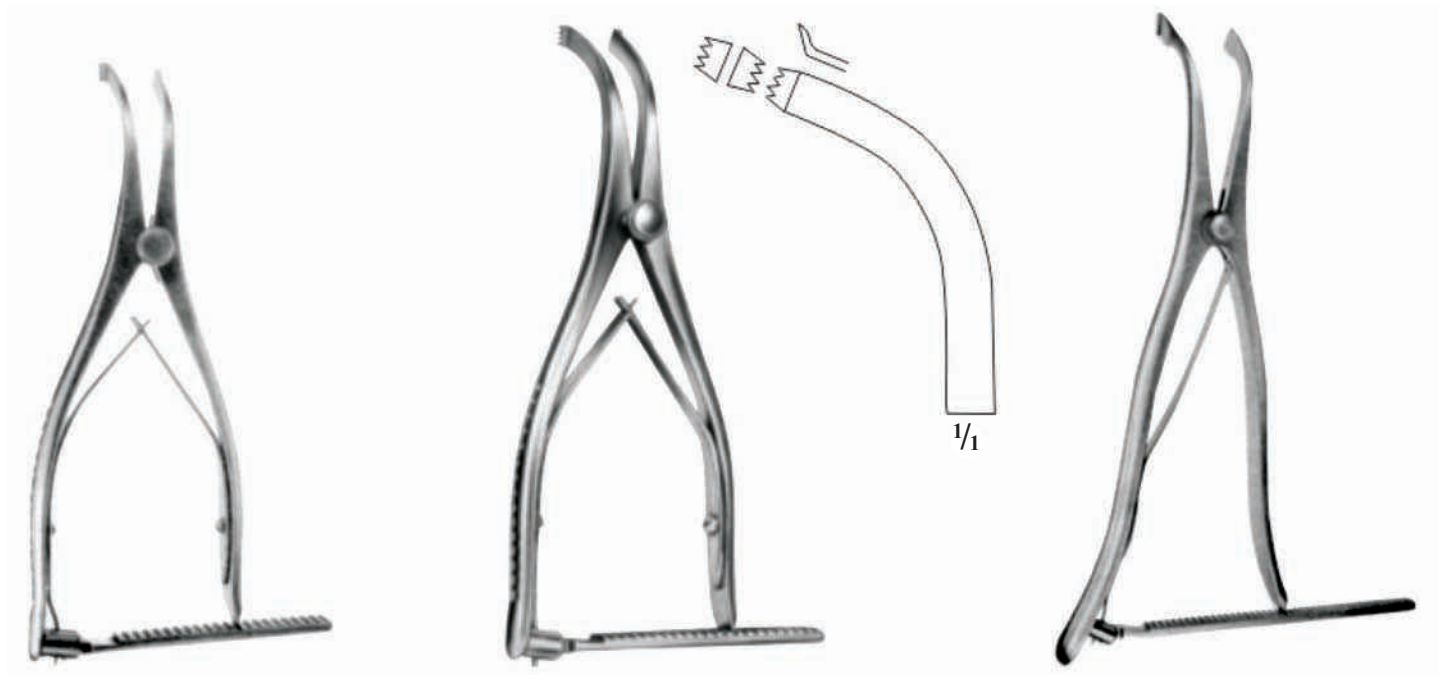

INGE
11-195-160
16 cm
Small pattern

INGE
11-196-170
17 cm

INGE, 26 cm
11-197-260 jaw with 5 mm
11-198-260 jaw with 10 mm
large pattern



CLOWARD
11-199-130
13 cm

LUMBAR LAMINA SPREADER
11-200-00
arm length: 87.5 mm
spread: 37.5 mm

CLOWARD
11-201-160
16 cm

11-202-140
14 cm

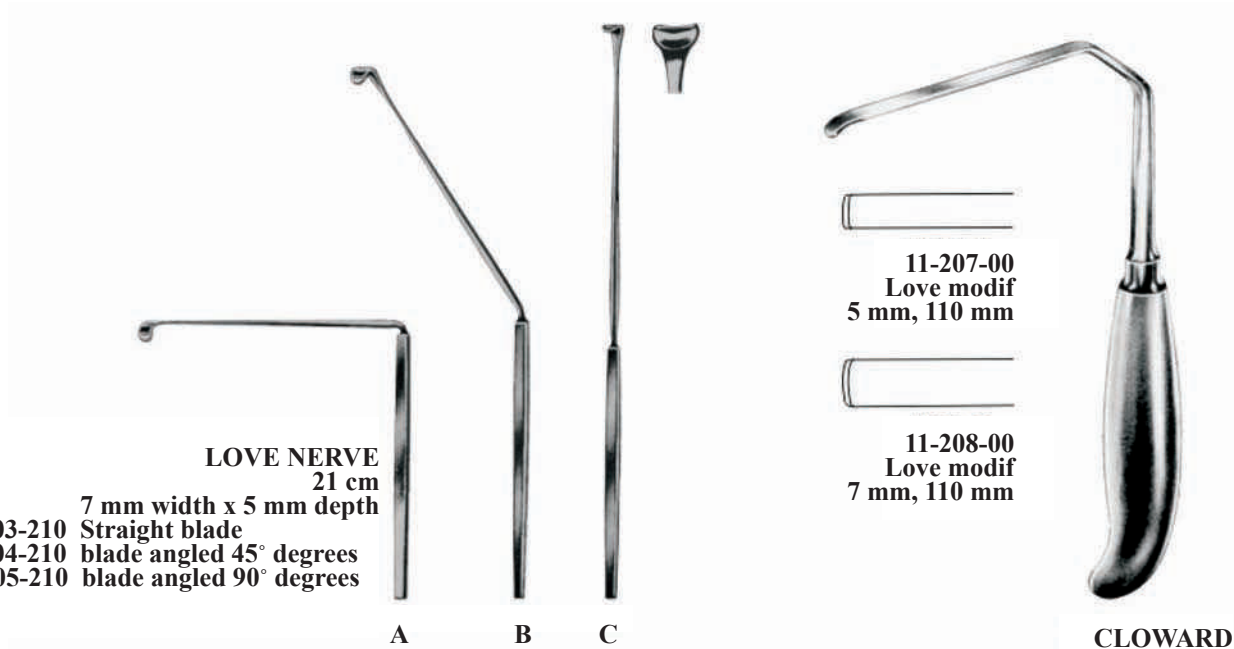

LOVE NERVE
21 cm
7 mm width x 5 mm depth

- A 11-203-210 Straight blade
- B 11-204-210 blade angled 45° degrees
- C 11-205-210 blade angled 90° degrees

A B C

11-207-00
Love modif
5 mm, 110 mm

11-208-00
Love modif
7 mm, 110 mm

CLOWARD
11-206-00
4 mm, 100 mm

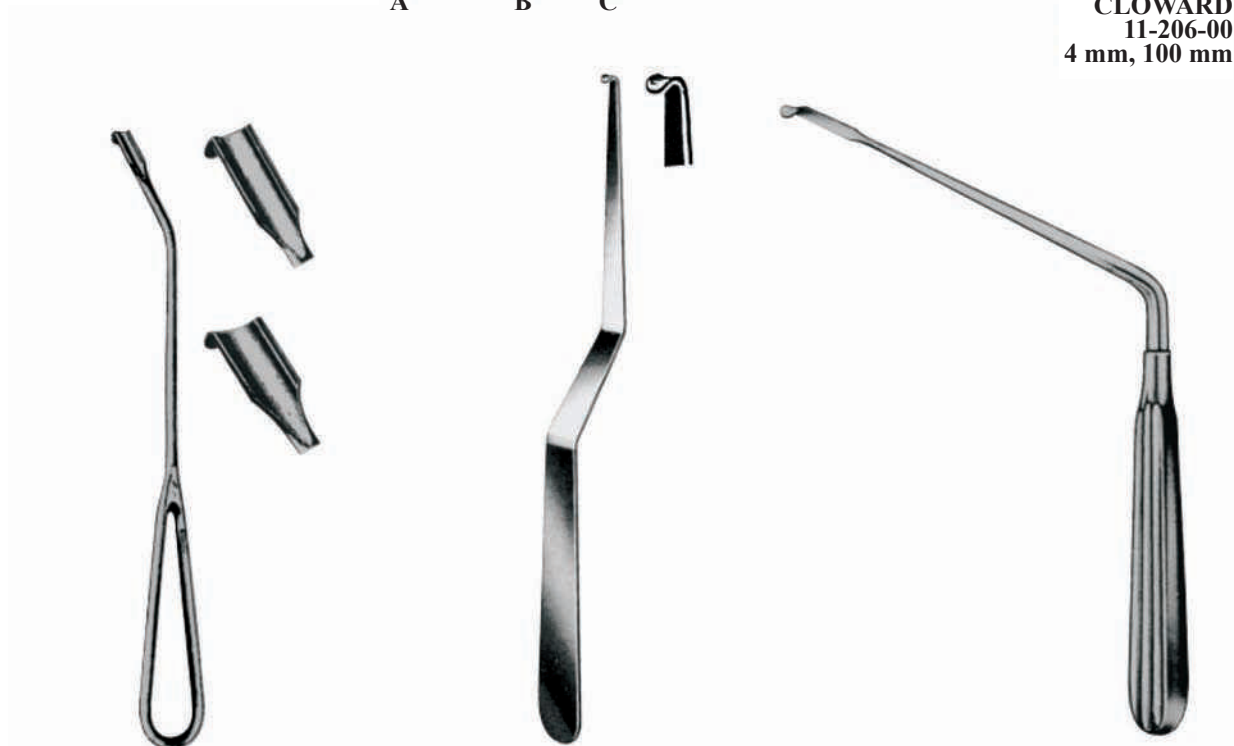

HOLSHER NERVE RETRACTOR
11-209-230 23 cm angled 7 mm blade
11-210-230 9 mm blade

NERVE ROOT RETRACTOR
11-211-00 6 mm blade
11-212-00 9 mm blade
Offset 225 mm

**SCOVILLE NERVE ROOT
RETRACTOR**
11-213-230 8 mm blade
11-214-230 13 mm blade
23 cm angled