

SECTION – 12

Ear nose throat surgery *оториноларингология*

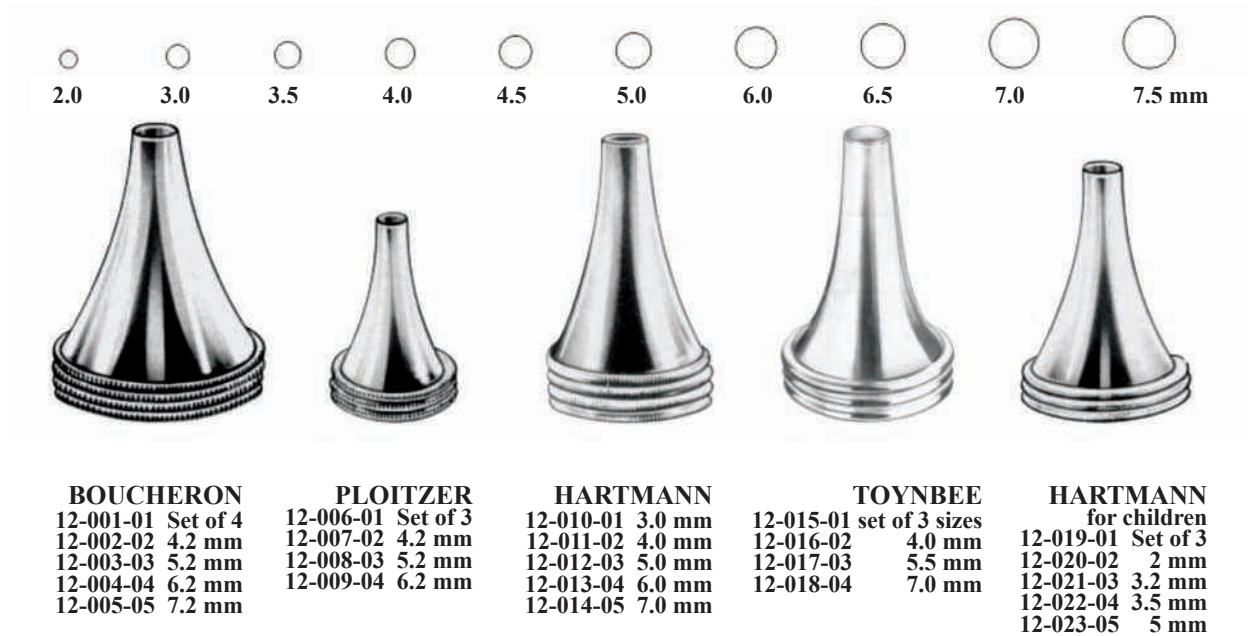



BOUCHERON
12-001-01 Set of 4
12-002-02 4.2 mm
12-003-03 5.2 mm
12-004-04 6.2 mm
12-005-05 7.2 mm

PLOITZER
12-006-01 Set of 3
12-007-02 4.2 mm
12-008-03 5.2 mm
12-009-04 6.2 mm

HARTMANN
12-010-01 3.0 mm
12-011-02 4.0 mm
12-012-03 5.0 mm
12-013-04 6.0 mm
12-014-05 7.0 mm

TOYNBEE
12-015-01 set of 3 sizes
12-016-02 4.0 mm
12-017-03 5.5 mm
12-018-04 7.0 mm

HARTMANN
for children
12-019-01 Set of 3
12-020-02 2 mm
12-021-03 3.2 mm
12-022-04 3.5 mm
12-023-05 5 mm

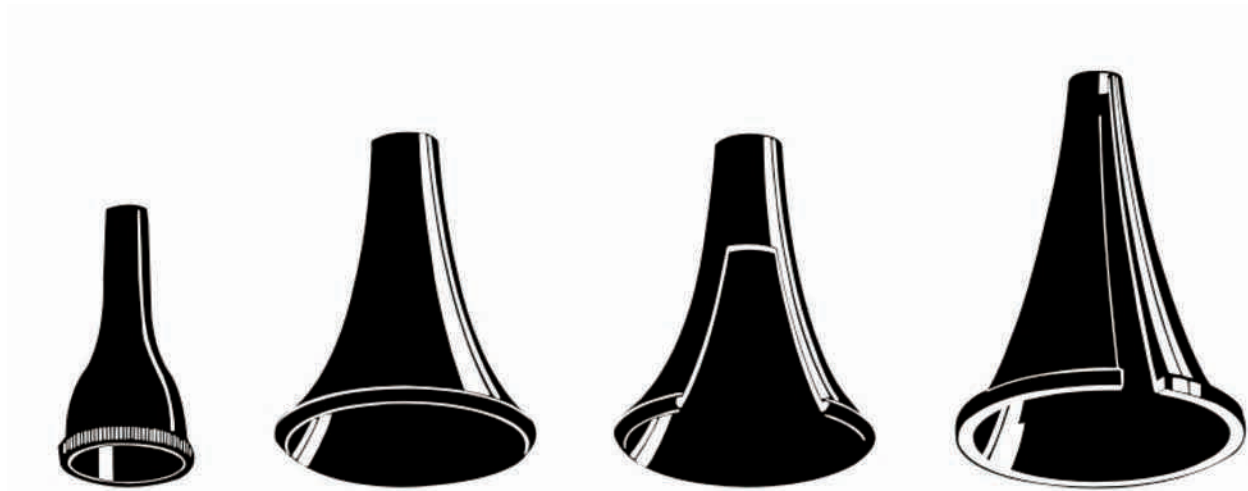

GRUBER AURAL SPECULA
Black finish, diam, 38 mm
12-024-01 Set of 4
12-025-02 3 mm
12-026-03 4 mm
12-027-04 5 mm
12-028-05 7 mm

ROSEN
Black finish, slotted round
ends, 35 mm
12-029-01 Set of 4
12-030-02 3 mm
12-031-03 4 mm
12-032-04 5 mm
12-033-05 7 mm

ROSEN
slotted round ends
Black finish, 35 mm
12-034-01 Set of 4
12-035-02 4 mm
12-036-03 5 mm
12-037-04 6 mm
12-038-05 7 mm

TUMARKIN
Tapered Slot
12-039-01 Size Set of 8
12-040-02 0 4.5 mm
12-041-03 1 6.5 mm
12-042-04 2 7.0 mm
12-043-05 3 7.5 mm
12-044-06 4 8.0 mm
12-045-07 5 8.5 mm
12-046-08 6 9.0 mm
12-047-09 7 11 mm

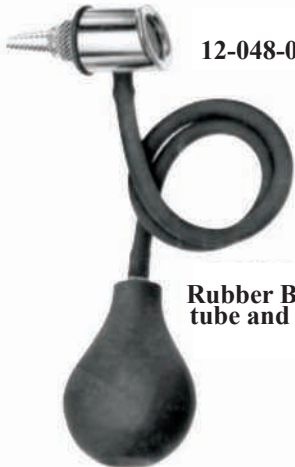

12-048-01

12-052-05
Rubber Bulb with rubber
tube and connection cone



12-049-02
Ear Speculum,
ø 5 mm



12-050-03
Ear Speculum,
ø 6 mm



12-051-04
Ear Speculum,
ø 7 mm

SIEGLE
Single Part



POLITZER
12-053-01
Air Douche, with
metal mount



Metal Nasal Tips
12-054-01 ø 18 mm
12-055-02 ø 21 mm
12-056-03 ø 23 mm



12-057-01
Metal Connector,
eustachian catheter to
Poltizer air douche

- 12-058-01 ø 2 mm ○
- 12-059-02 ø 2.5 mm ○
- 12-060-03 ø 3 mm ○
- 12-061-04 ø 4 mm ○
- 12-062-05 ø 5 mm ○

HARTMANN
Eustachian Catheters

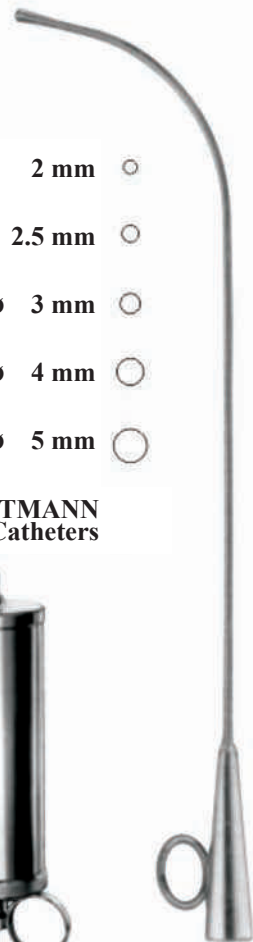

REINER
12-063-000
Tip Only



REINER
12-064-000
Tip Only



REINER
12-065-000
Shield

12-066-000 50ML Complete
75ML Complete
12-067-000 75ML Complete
150ML Complete

With Tip & Shield



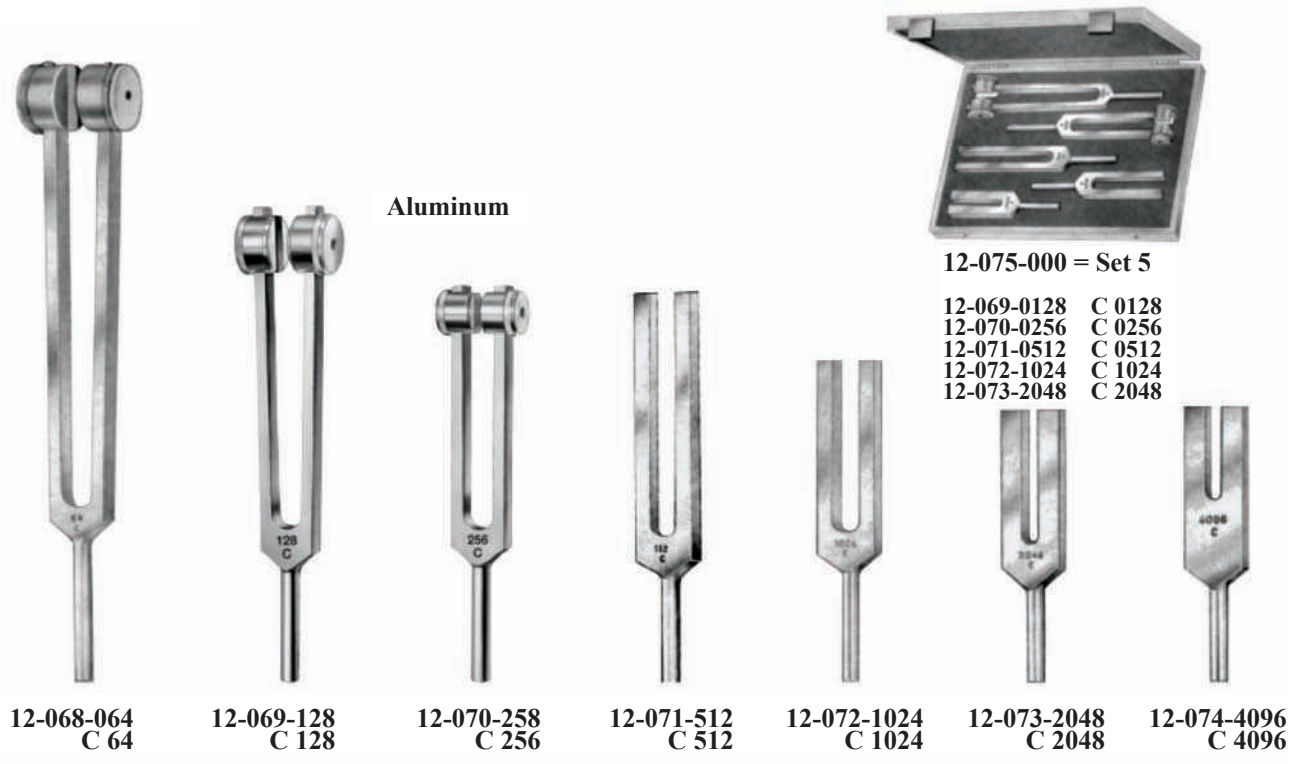

Aluminum

12-075-000 = Set 5

| | | | | | | |
|--------------------|---------------------|---------------------|---------------------|-----------------------|-----------------------|-----------------------|
| | | | | | | |
| 12-068-064 C 64 | 12-069-128 C 128 | 12-070-258 C 256 | 12-071-512 C 512 | 12-072-1024 C 1024 | 12-073-2048 C 2048 | 12-074-4096 C 4096 |



| | | | | |
|-----------------|--------------|------------------------|---------------------------------------|------------------------------------|
| | | | | |
| HARTMANN | LUCAE | HARTMANN-FRENCH | HARTMANN 12-093-000 = Set 6 | LUCAE 12-094-000 = Set 6 |

| | | | | | |
|----------------|---------------------|-------------|-------------|-------------|--------------------|
| | 12-076-128 | 12-082-128 | 12-091-128 | 12-076-128 | 128C |
| C ¹ | 256 c ¹ | 12-077-256 | 12-083-256 | 12-077-256 | 256C ¹ |
| C ² | 512 c ² | 12-078-512 | 12-084-512 | 12-078-512 | 512C ² |
| C ³ | 1024 c ³ | 12-079-1024 | 12-085-1024 | 12-079-1024 | 1024C ³ |
| C ⁴ | 2048 c ⁴ | 12-080-2048 | 12-086-2048 | 12-080-2048 | 2048C ⁴ |
| C ⁵ | 4096 c ⁵ | 12-081-4096 | 12-087-4096 | 12-081-4096 | 4096C ⁵ |

| | | | | | |
|----------------|---------------------|-------------|-------------|-------------|--------------------|
| | 12-082-128 | 12-083-256 | 12-084-512 | 12-082-128 | 128C |
| C ¹ | 256 c ¹ | 12-085-1024 | 12-086-2048 | 12-083-256 | 256C ¹ |
| C ² | 512 c ² | 12-087-4096 | | 12-084-512 | 512C ² |
| C ³ | 1024 c ³ | | | 12-085-1024 | 1024C ³ |
| C ⁴ | 2048 c ⁴ | | | 12-086-2048 | 2048C ⁴ |
| C ⁵ | 4096 c ⁵ | | | 12-087-4096 | 4096C ⁵ |

| | | | | | |
|----------------|--------------------|------------|------------|------------|-------------------|
| | 12-088-016 | 12-089-032 | 12-090-064 | 12-088-016 | 16C ² |
| C ¹ | 32 c ¹ | 12-091-128 | 12-092-256 | 12-089-032 | 32C ² |
| C ² | 64 c ² | | | 12-090-064 | 64C |
| C ³ | 128 c ³ | | | 12-091-128 | 128C |
| C ⁴ | 256 c ⁴ | | | 12-092-256 | 256C ¹ |

| | | | | | |
|--|------------|------------|------------|------------|------------|
| HARTMANN-FRENCH 12-095-000 = Set 7 | 12-088-016 | 12-089-032 | 12-090-064 | 12-091-128 | 12-092-256 |
|--|------------|------------|------------|------------|------------|

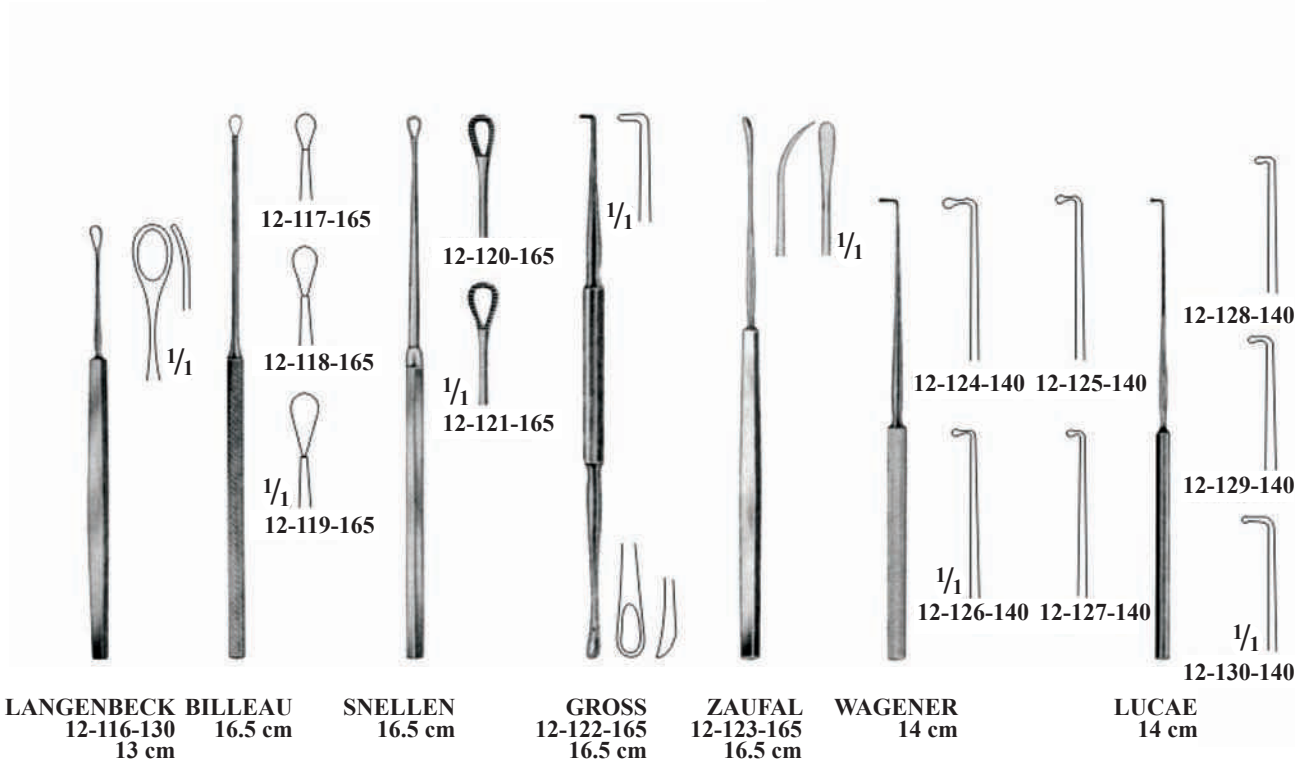
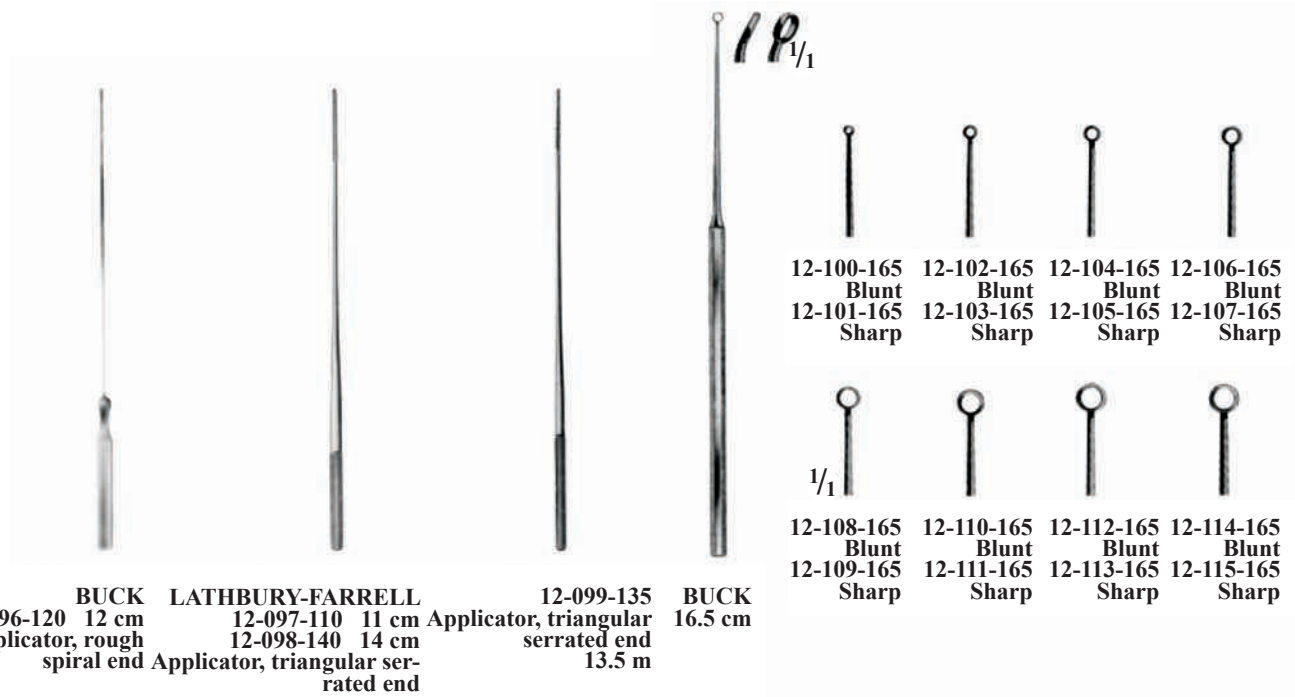

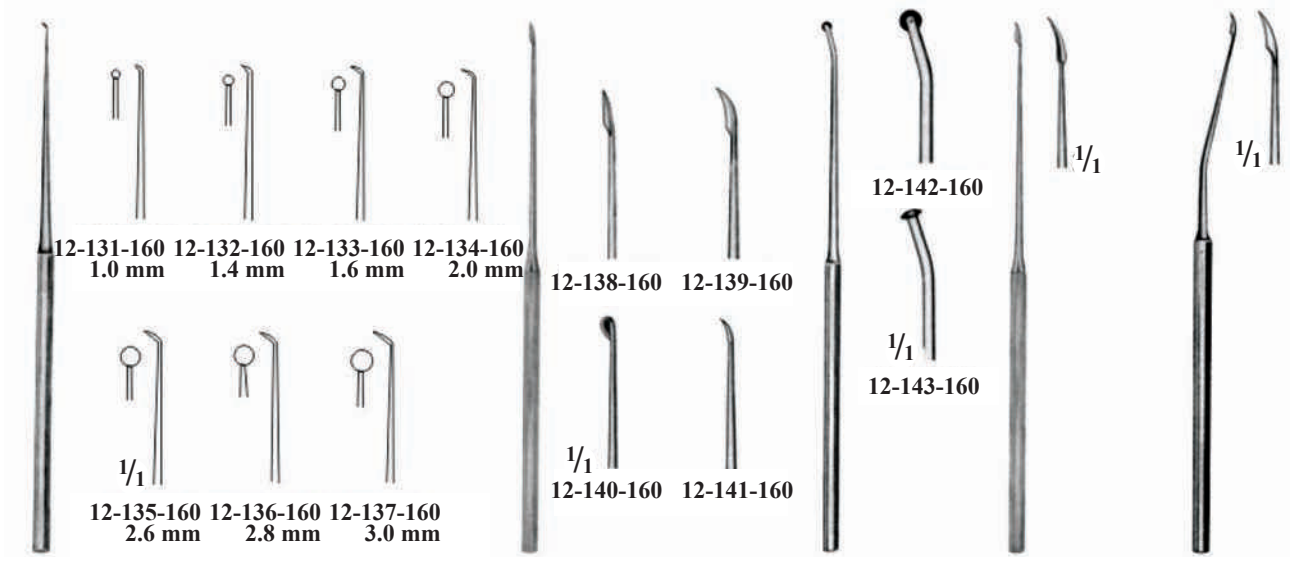

ROSEN
16 cm

PLESTER
16 cm

SCHUKNECHT 16 cm
SCHUKNECHT 12-144-160 16 cm
SCHUKNECHT 12-145-160 16 cm

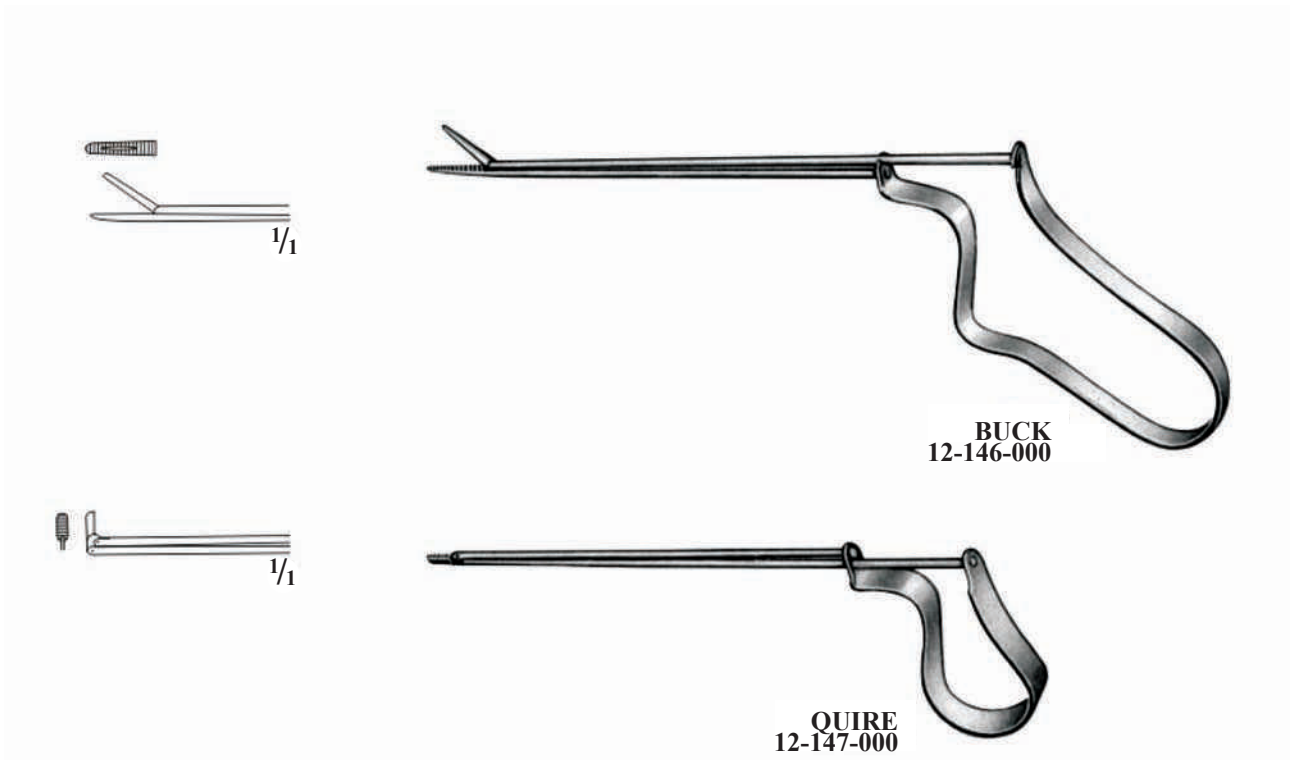

BUCK
12-146-000

QUIRE
12-147-000

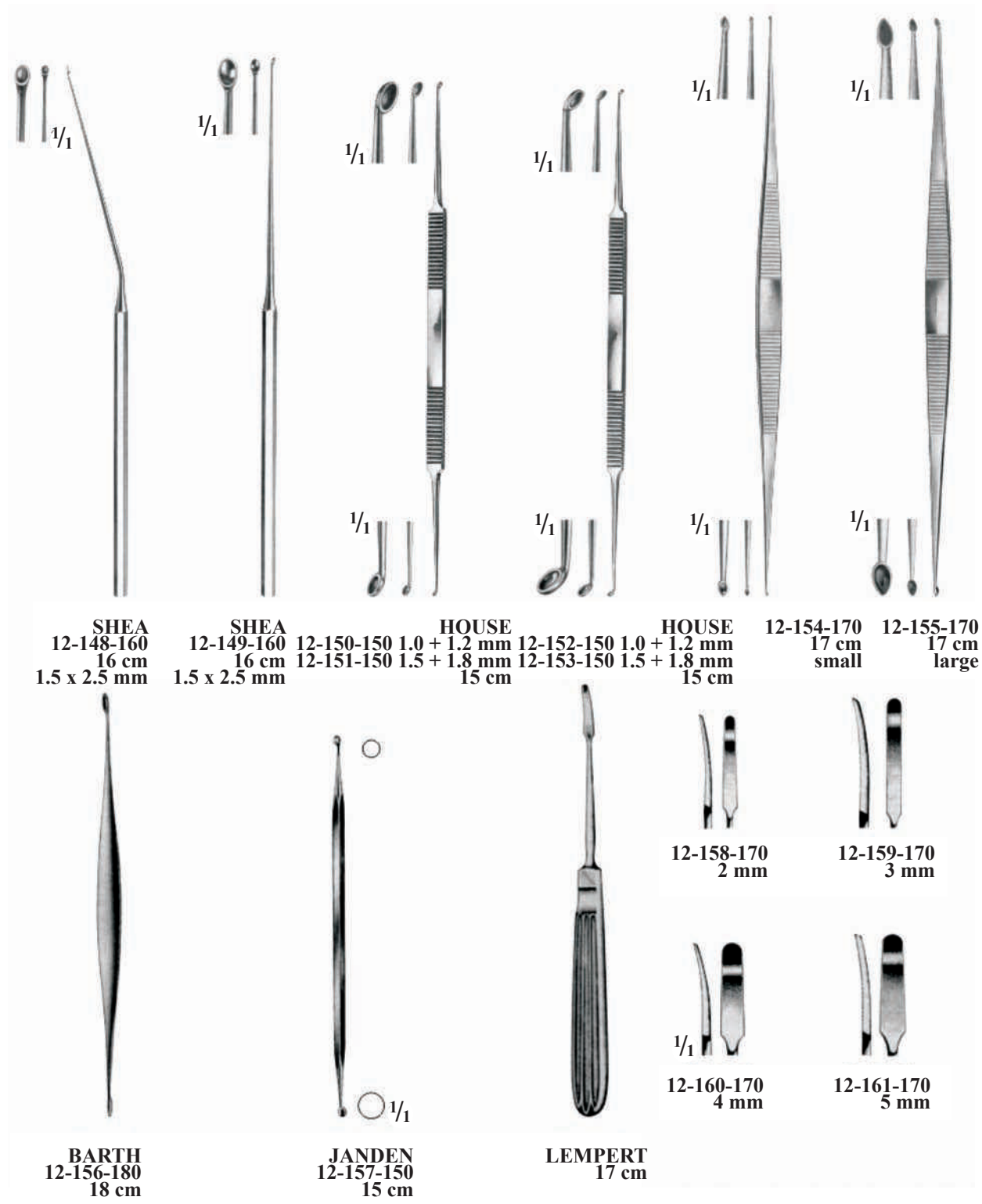

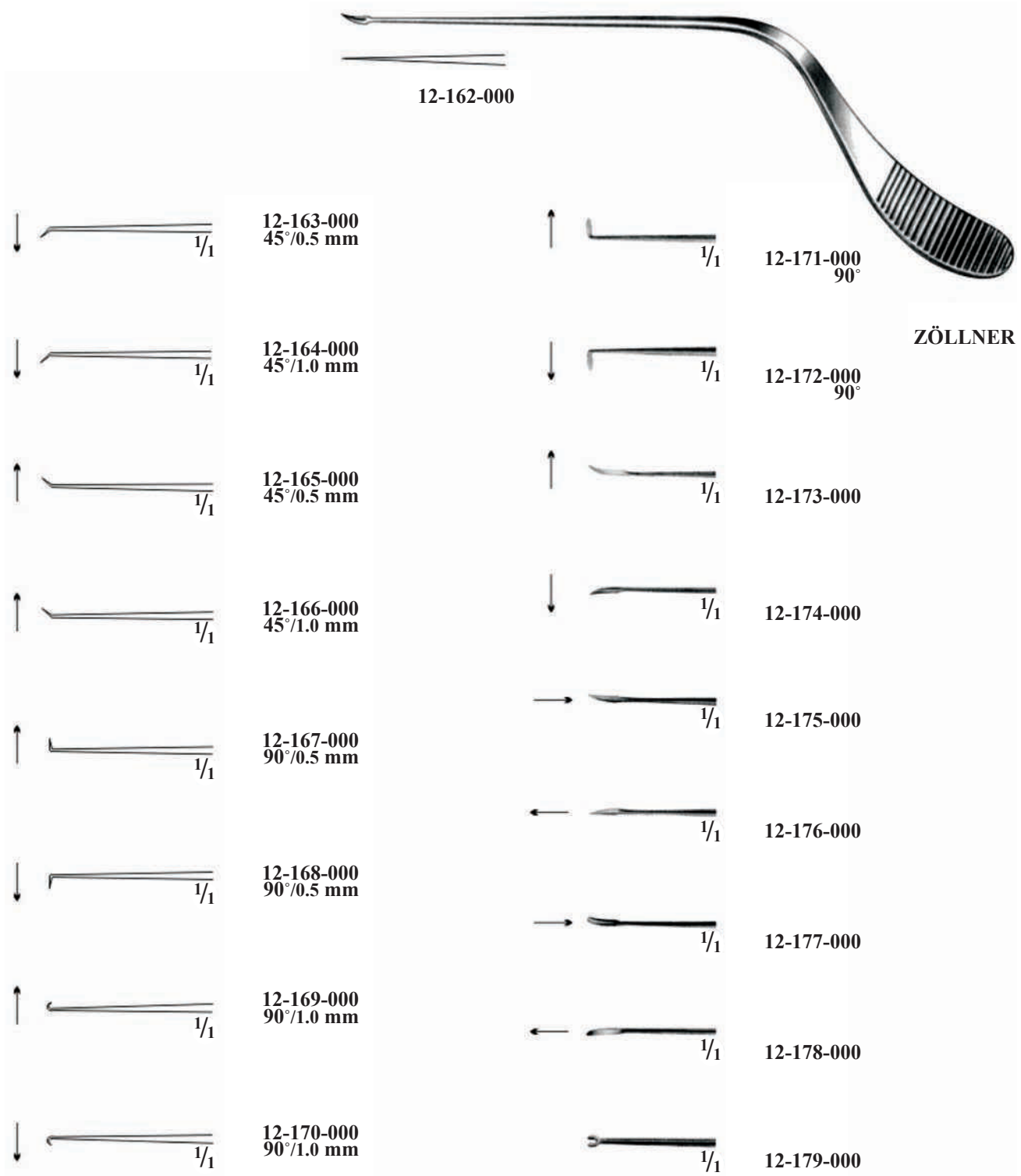



HARTMANN-WULLSTEIN
12-180-000



HARTMANN-WULLSTEIN
12-181-000



HARTMANN
12-182-085 8.5 cm
12-183-140 14.0 cm



HARTMANN
12-184-000
12-185-000



HARTMANN-NOYES
12-186-000



DUCKBILL
12-187-000



WEINGÄRTNER
12-188-000



HARTMANN
12-189-000 = 2.0 mm
12-190-000 = 2.5 mm
12-191-000 = 3.0 mm



HARTMANN
12-192-000 = 2.0 mm
12-193-000 = 2.5 mm
12-194-000 = 3.0 mm



STRÜMPEL
12-195-000



HARTMANN
12-196-000



HARTMANN
12-197-000



HARTMANN-HOFFMANN
12-198-000



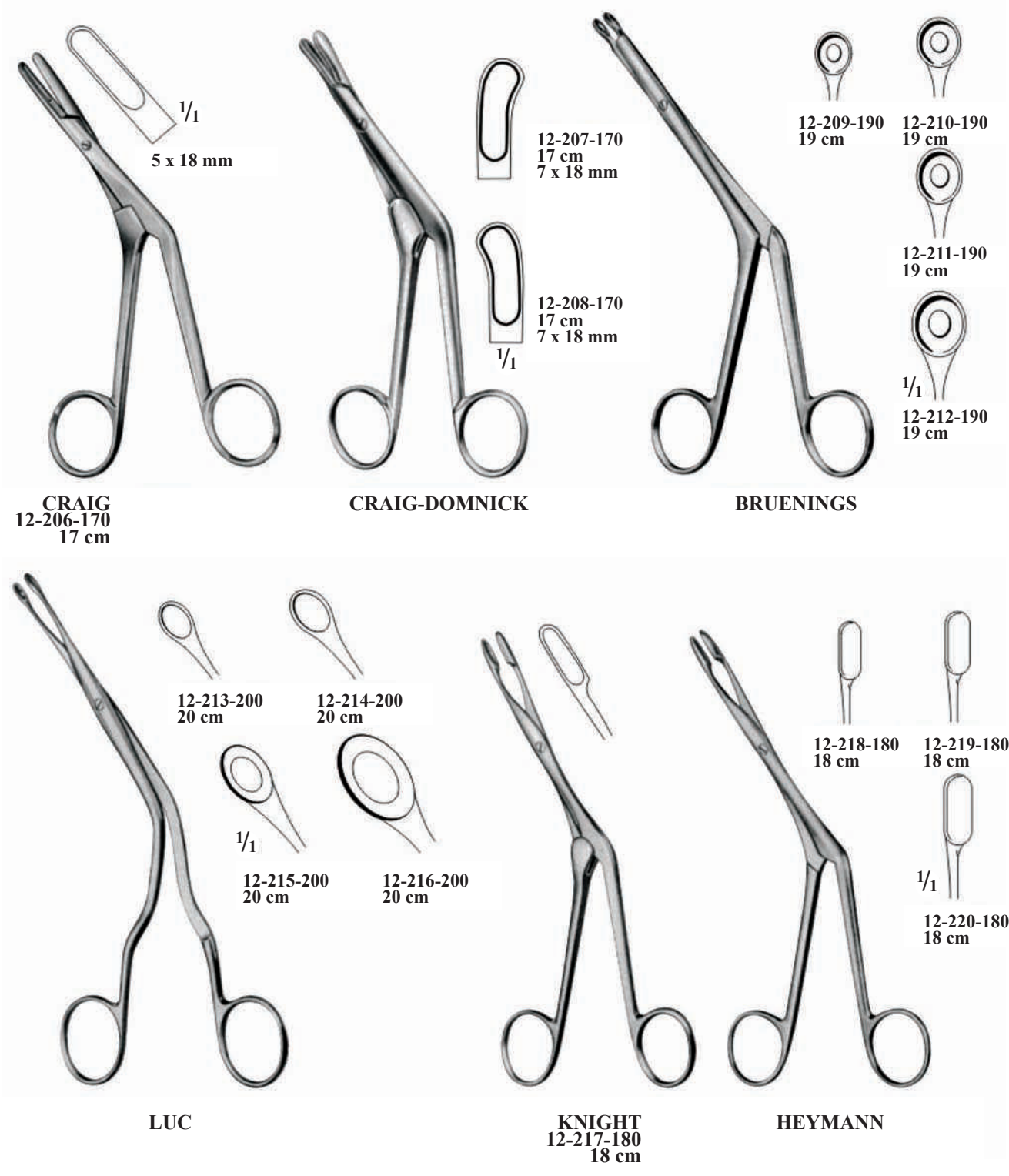



HARTMANN
12-221-160
16 cm
12-222-200
20 cm



HEYMANN-KNIGHT
12-223-180
18 cm



LUBET-BARBON
12-224-200
20 cm



KILLIAN
12-225-170
17 cm



WEST

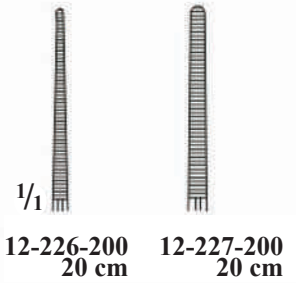

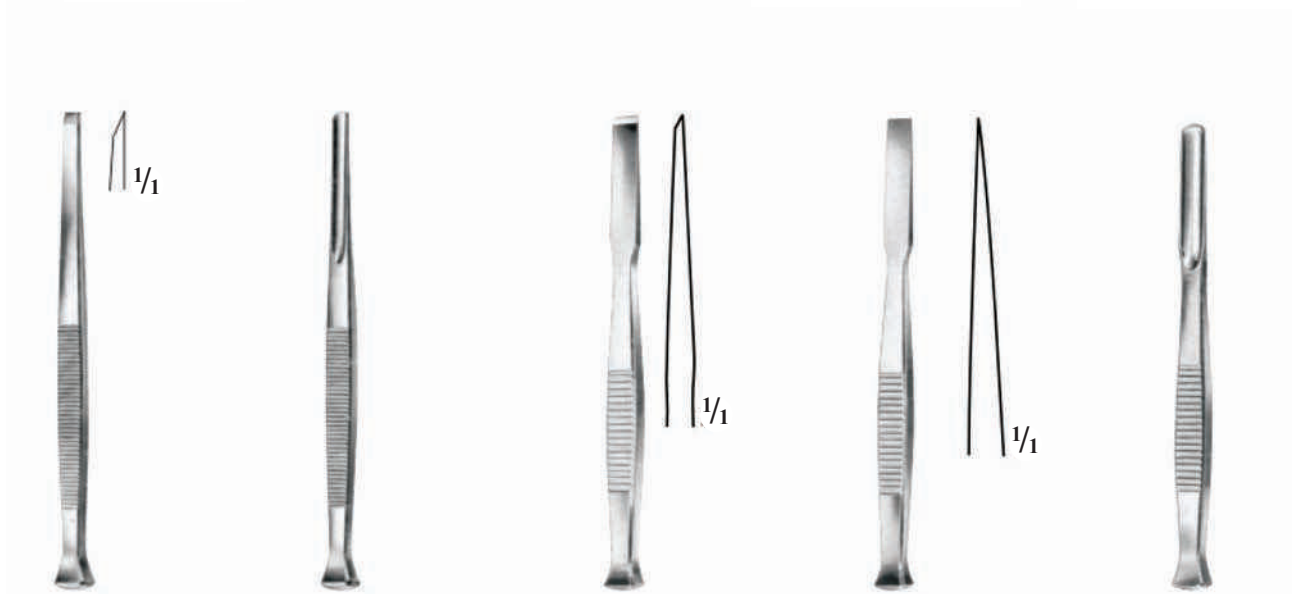
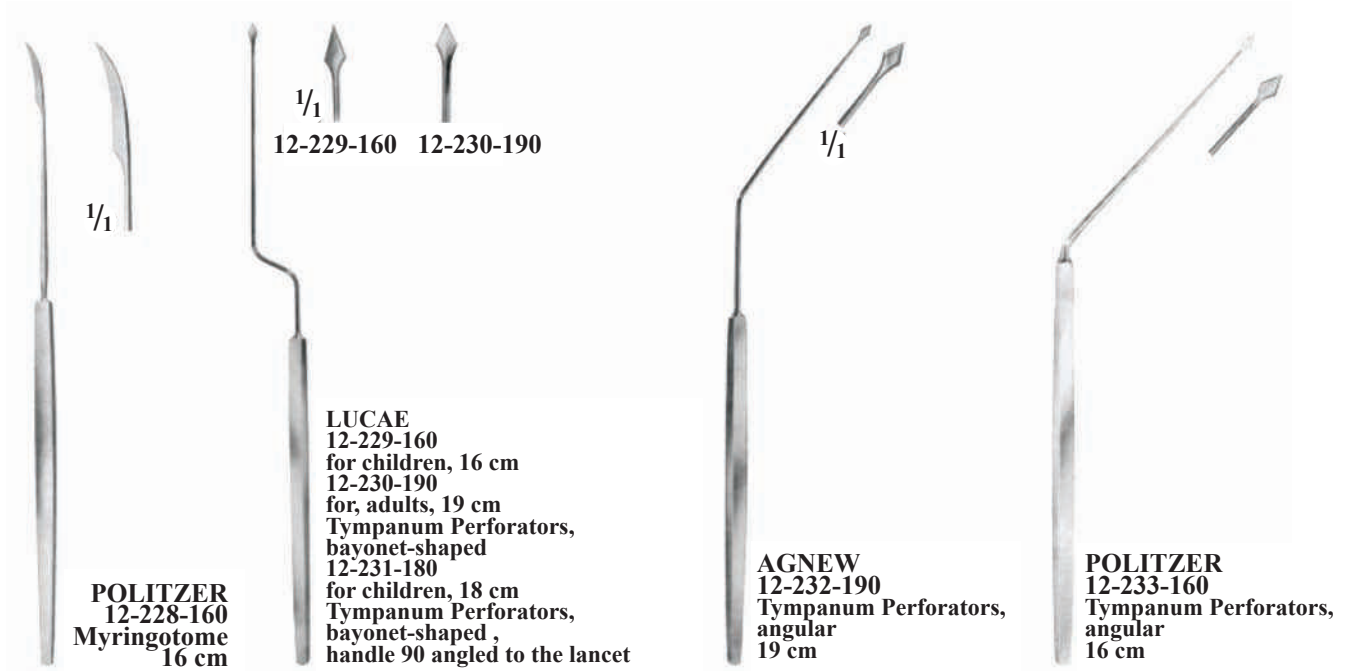

PARTSCH
12-234-140 3 mm
12-235-140 4 mm
12-236-140 5 mm
12-237-140 6 mm
14 cm

PARTSCH
12-238-140 3 mm
12-239-140 4 mm
12-240-140 5 mm
12-241-140 6 mm
14 cm

JANSEN
12-242-140 4 mm
12-243-140 6 mm
12-244-140 8 mm
12-245-140 10 mm
12-246-140 12 mm
14 cm

JANSEN
12-247-140 4 mm
12-248-140 6 mm
12-249-140 8 mm
12-250-140 10 mm
12-251-140 12 mm
14 cm

JANSEN
12-252-140 4 mm
12-253-140 6 mm
12-254-140 8 mm
12-255-140 10 mm
12-256-140 12 mm
14 cm

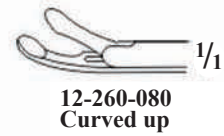
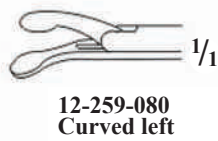
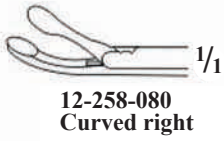
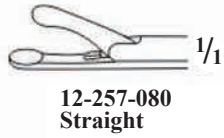

12-262-080
Mixro scissor
straight, sharp / sharp



BELLUCCI
12-263-080
Mixro scissor
curved up, blunt / blunt

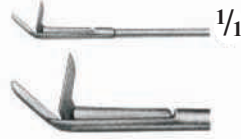

BELLUCCI
12-265-080
Mixro scissor
curved to the right,
sharp / sharp



BELLUCCI
12-264-080
Mixro scissor
curved to the left,
sharp / sharp



BELLUCCI
12-266-080
Mixro scissor
horizontal cutting

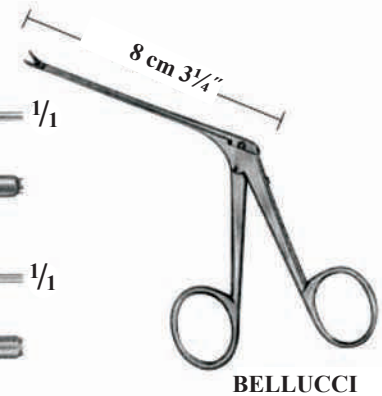

CRURA-NIPPER
12-267-080

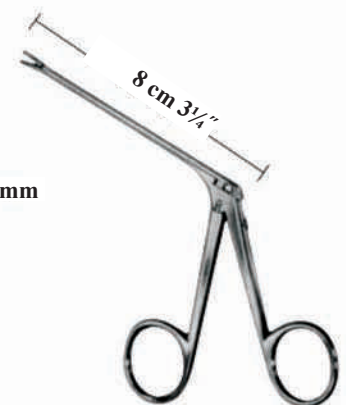
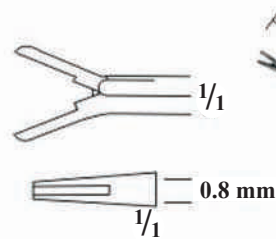

McGEE
12-268-080

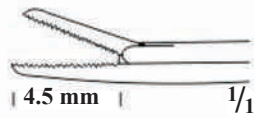

12-272-080
8 cm
Straight-Serrated
4.5 x 0.8 mm

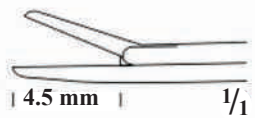

12-273-080
8 cm
Straight-Serrated
4.5 x 0.8 mm

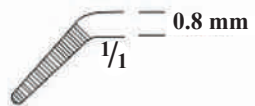

12-274-000

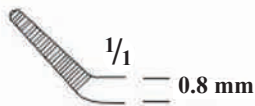

12-275-000

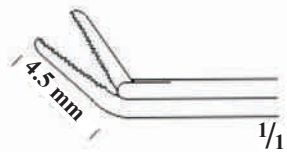

12-276-000

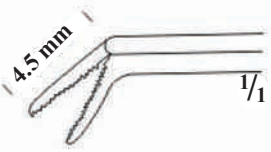

12-277-000

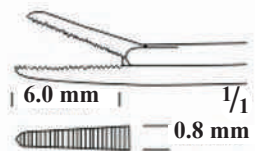

12-278-080
8 cm
Straight-Serrated
6 x 0.8 mm

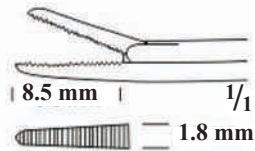

12-279-080
8 cm
Straight-Serrated
8.5 x 1.8 mm

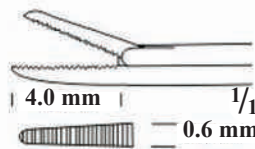

12-280-080
8 cm
Straight-Serrated
4 x 0.6 mm

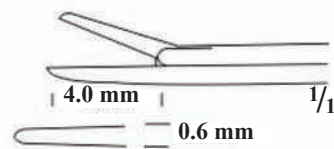

12-281-000



MICRO-EAR FORCEPS



MICRO-EAR SCISSORS

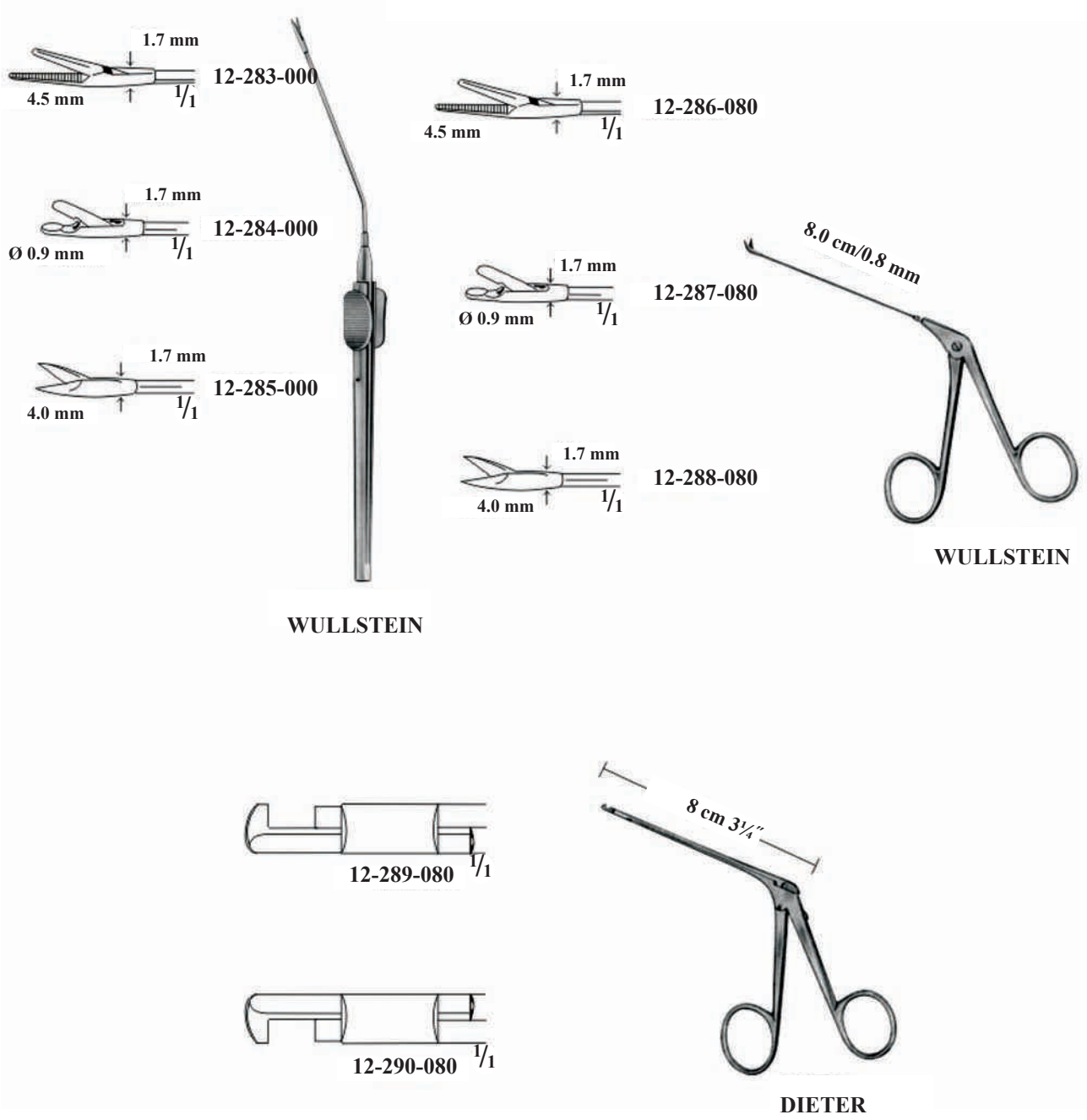



HEYMANN
12-291-200
Nasal Scissors
20 cm

KIRSTEIN
12-292-180
Nasal Scissors,
blades serrated
18 cm

OLIVECRONE
12-293-225
Nasal Scissors
22.5 cm

SNARE WIRE
12-294-001
in coils of 10 meters
Ø 0,3 mm

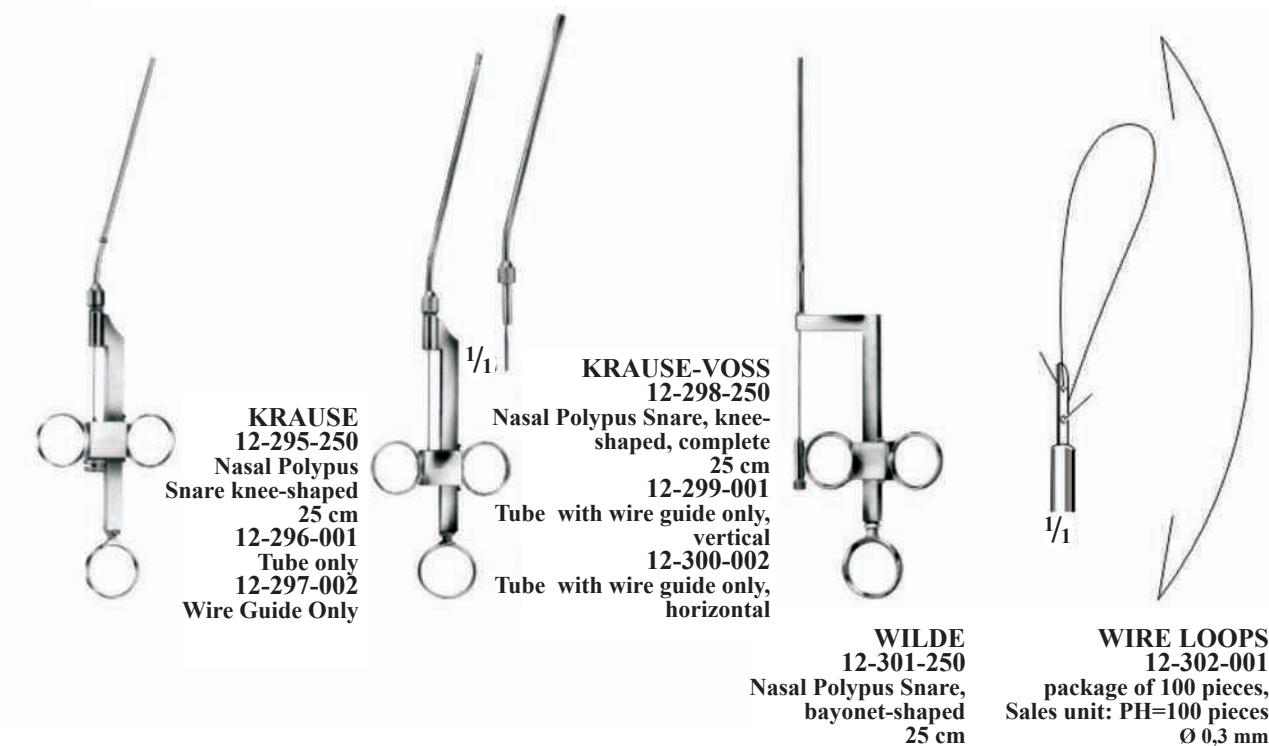

KRAUSE
12-295-250
Nasal Polypus
Snare knee-shaped
25 cm
12-296-001
Tube only
12-297-002
Wire Guide Only

KRAUSE-VOSS
12-298-250
Nasal Polypus Snare, knee-
shaped, complete
25 cm
12-299-001
Tube with wire guide only,
vertical
12-300-002
Tube with wire guide only,
horizontal

WILDE
12-301-250
Nasal Polypus Snare,
bayonet-shaped
25 cm

WIRE LOOPS
12-302-001
package of 100 pieces,
Sales unit: PH=100 pieces
Ø 0,3 mm

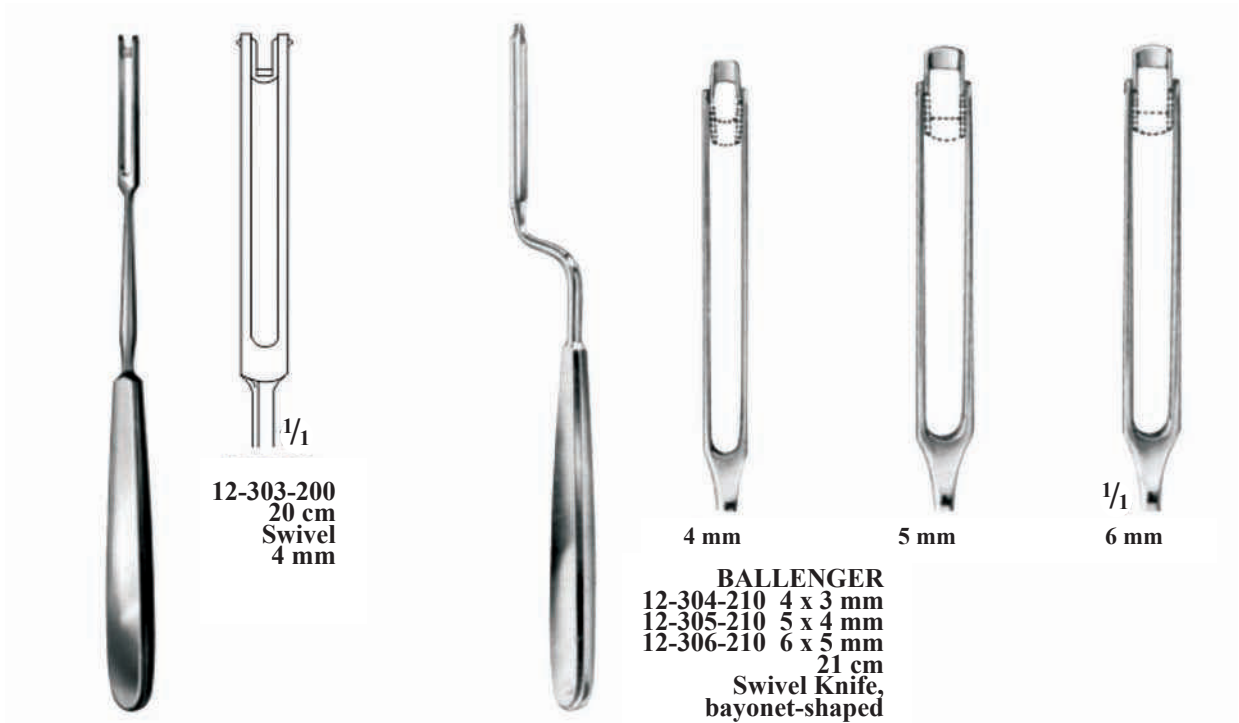

12-303-200
20 cm
Swivel
4 mm

BALLENGER
12-304-210 4 x 3 mm
12-305-210 5 x 4 mm
12-306-210 6 x 5 mm
21 cm
Swivel Knife,
bayonet-shaped

BALLENGER



JOSEPH
12-307-170
straight

JOSEPH
12-308-170
bayonet shaped
right curved

JOSEPH
12-309-170 bayonet
shaped left curved,
nasal saws

12-310-180
Mallet, Septum Gouge, head with
interchangeable nylon inserts,
approx. 140 g, 18 cm
12-311-180
Pair of interchangeable
nylon inserts, for mallet

COTTLE
12-312-190
19 cm
Mallet, 1 plain face
1 convex face
approx. 240 g

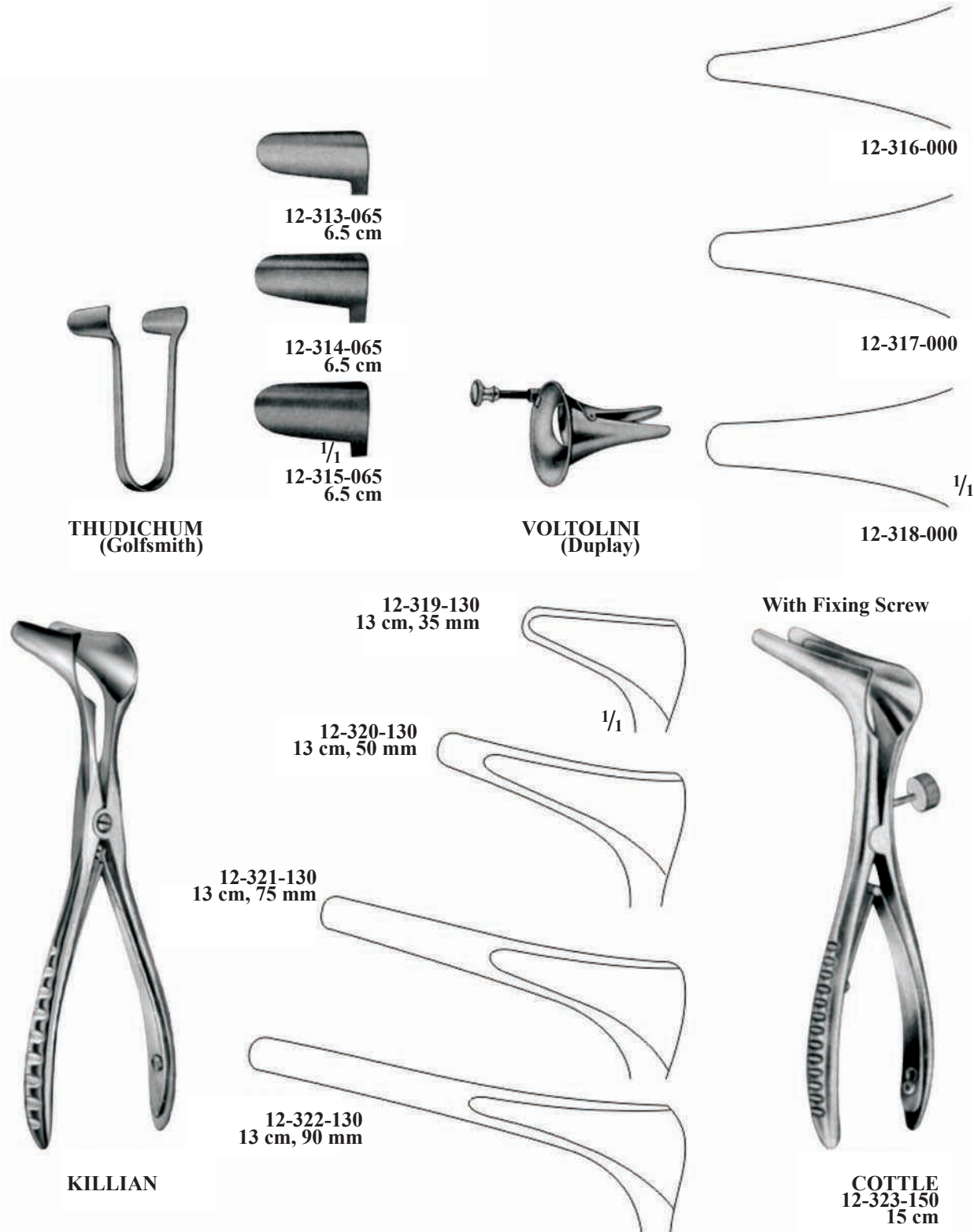

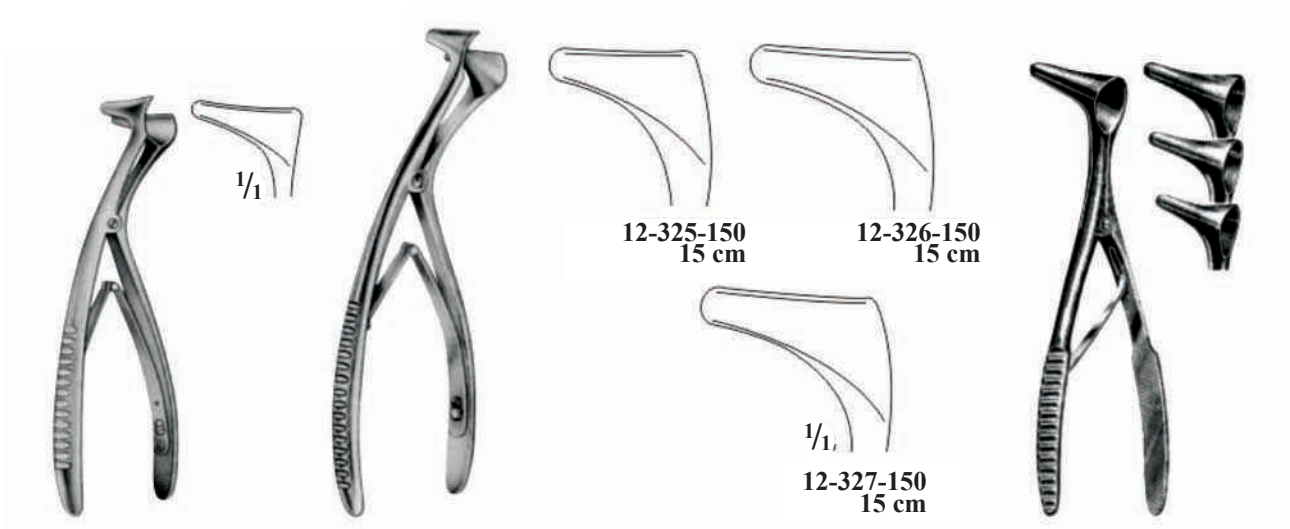

BECKMANN
12-324-150
15 cm

BECKMANN

VIENNA NASAL
12-328-001 - Infant
12-329-002 - Child
12-330-003 - Adult

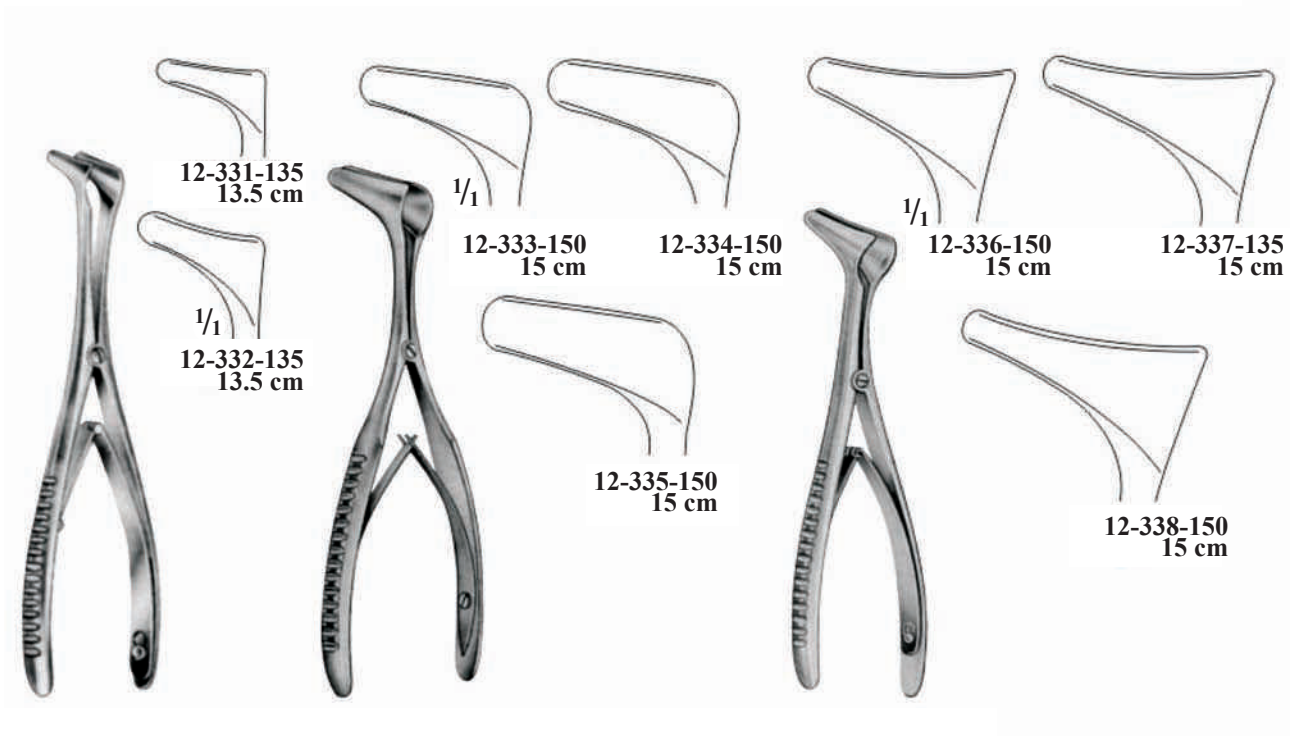

TIECK-HALLE

HARTMANN-HALLE

HARTMANN

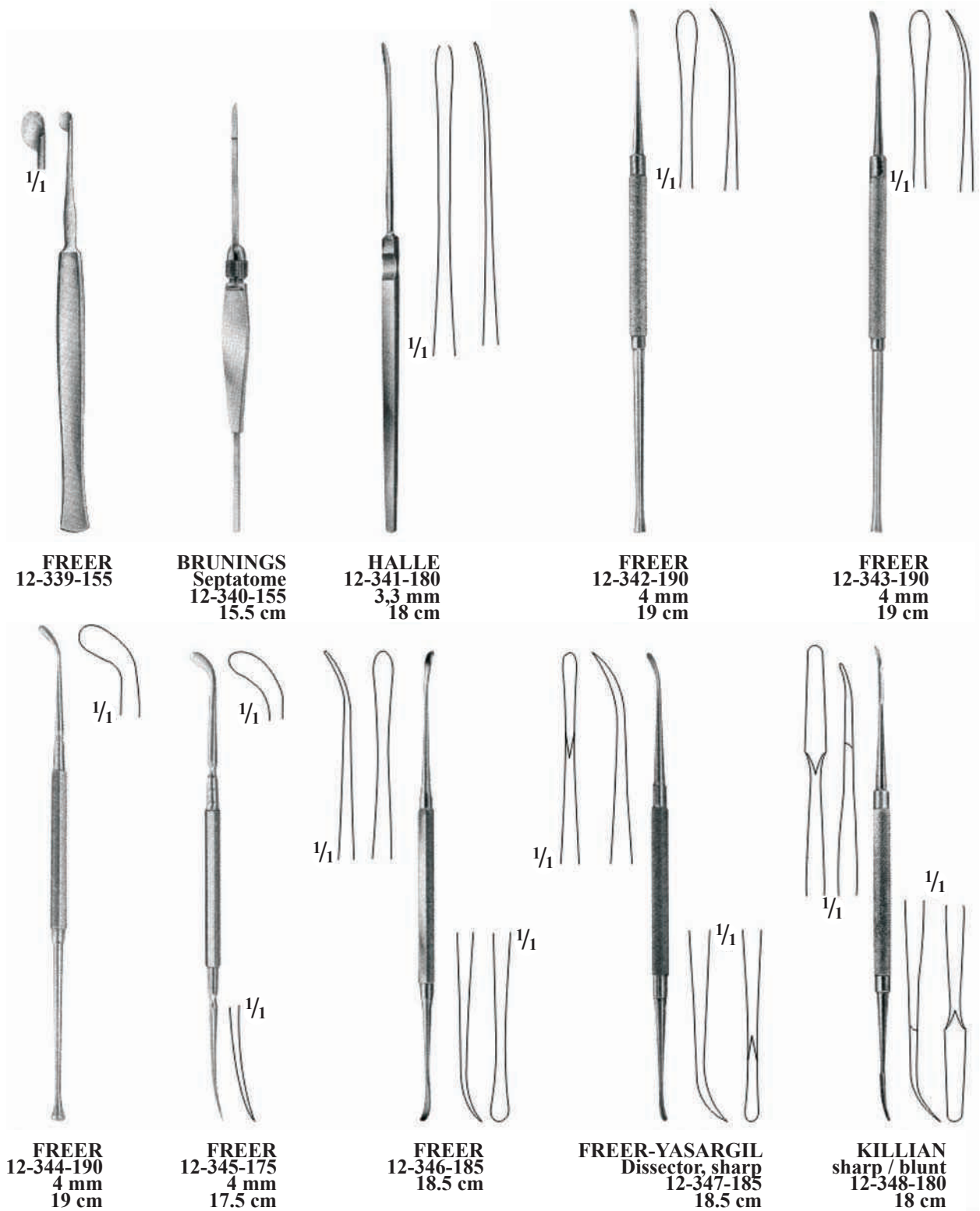

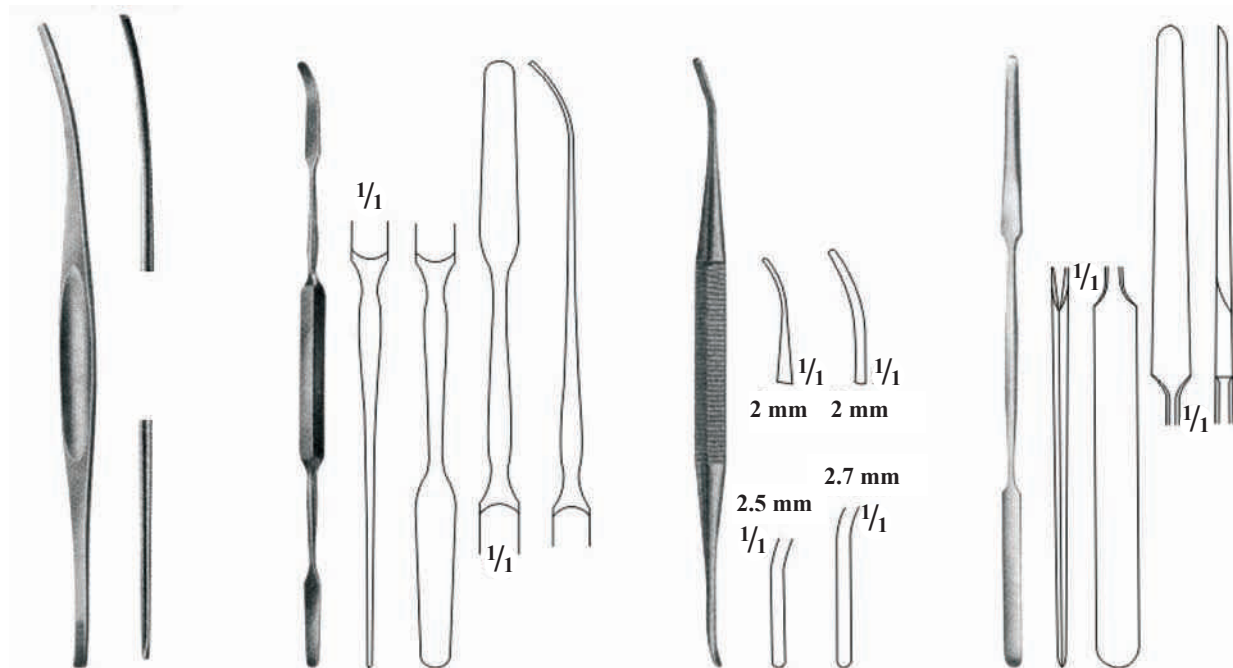

HILL
12-349-220
22 cm
semi-sharp / blunt

MACDONALD
12-350-190
19 cm
blunt / blunt

WATRON-CHEYNE
12-351-190
19 cm

KILLIAN
12-352-185
18.5 cm
sharp / blunt

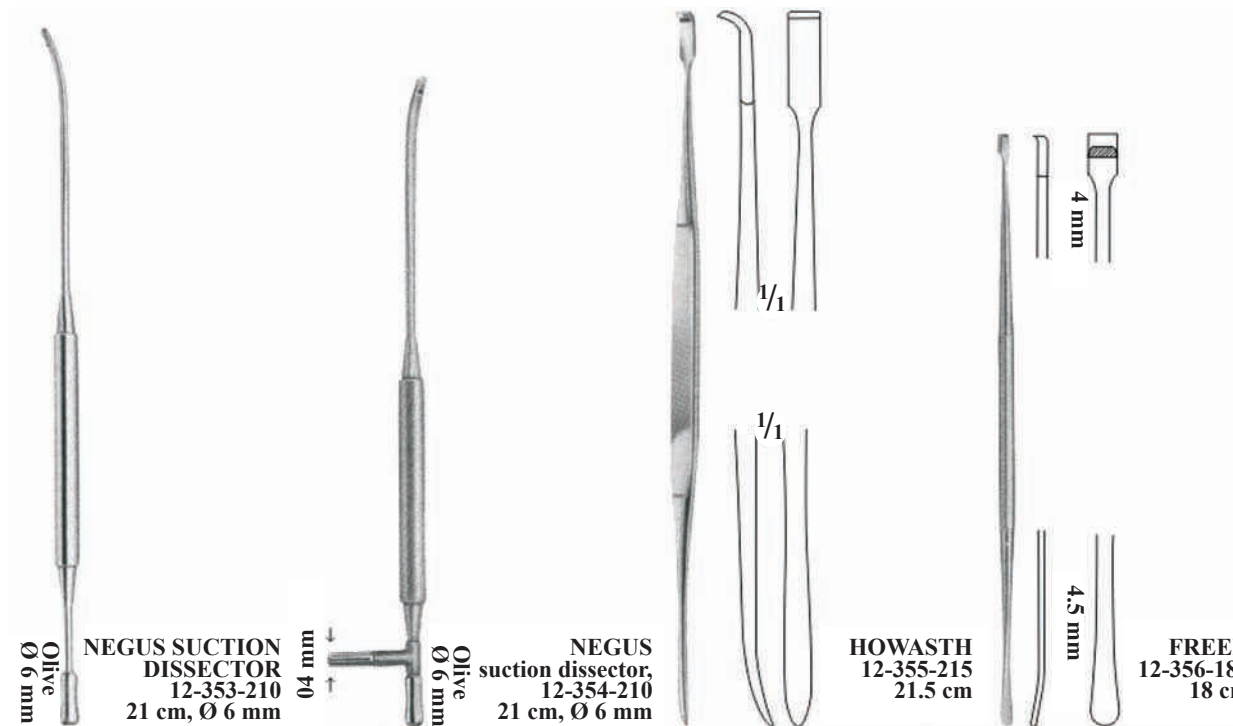

**NEGUS SUCTION
DISSECTOR**
12-353-210
21 cm, Ø 6 mm

**NEGUS
suction dissector,**
12-354-210
21 cm, Ø 6 mm

HOWASTH
12-355-215
21.5 cm

FREER
12-356-180
18 cm



ST CLAIR THOMPSON
12-357-160
sharp / blunt
16 cm

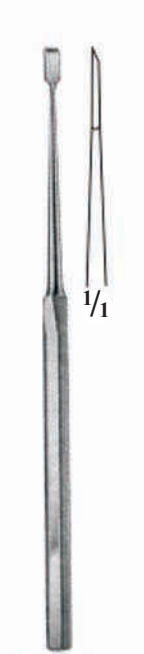

FREER
12-358-160
sharp / blunt
straight
16 cm

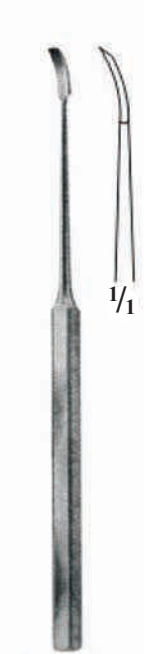

FREER
12-359-160
sharp / blunt
curved
16 cm



PENNINGTON
12-360-210
21 cm



COTTLE
12-361-200
20 cm



COTTLE
12-362-200
20 cm

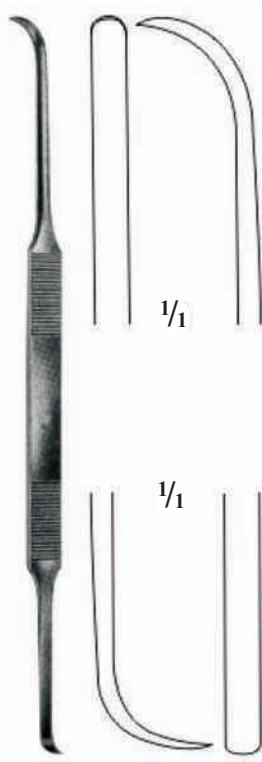

COTTLE
12-363-200
20 cm

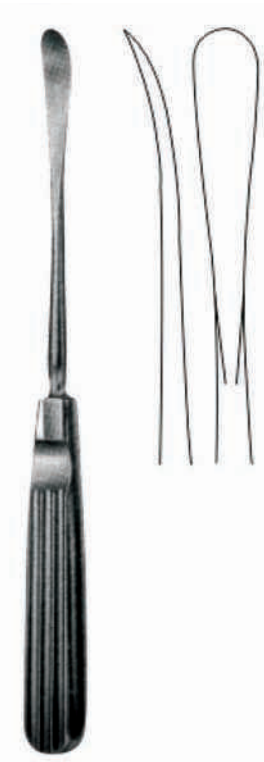

COTTLE
12-364-200
curved, sharp
20 cm



HALLE
12-365-180
blunt
18 cm



FREER
12-366-200
sharp
20 cm

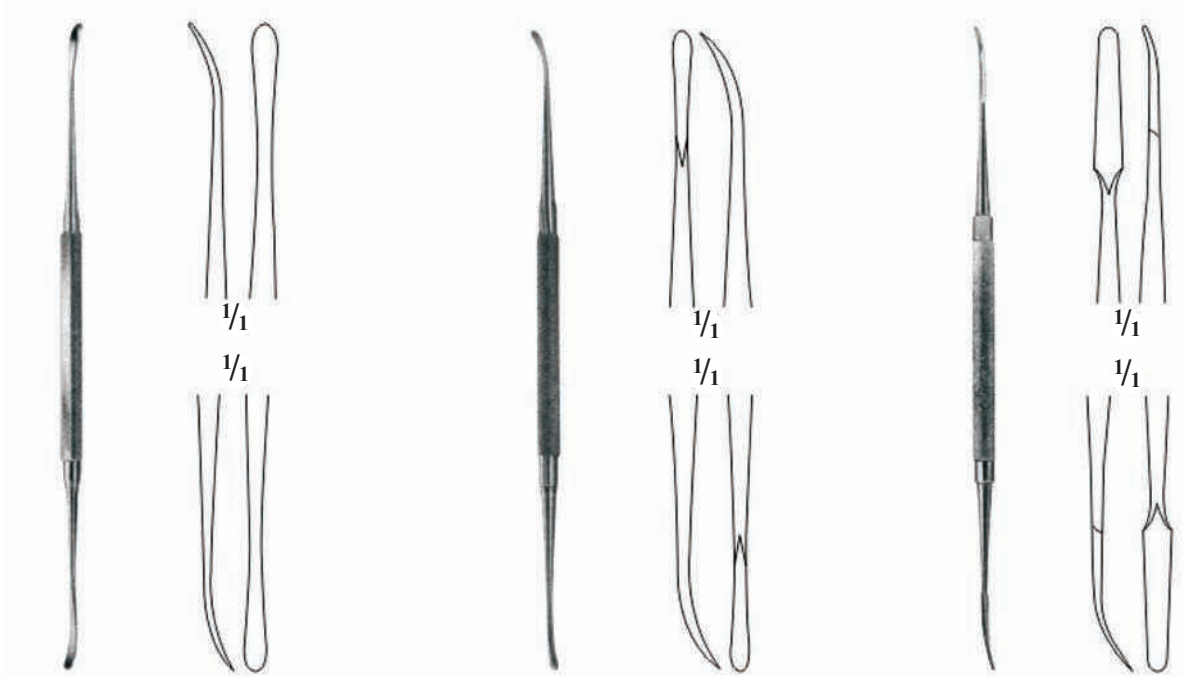

FREER
sharp blunt
12-367-185
18.5 cm

FREER YASARGIL
sharp
12-368-185
18.5 cm

FREER YASARGIL
sharp/blunt
12-369-185
18.5 cm

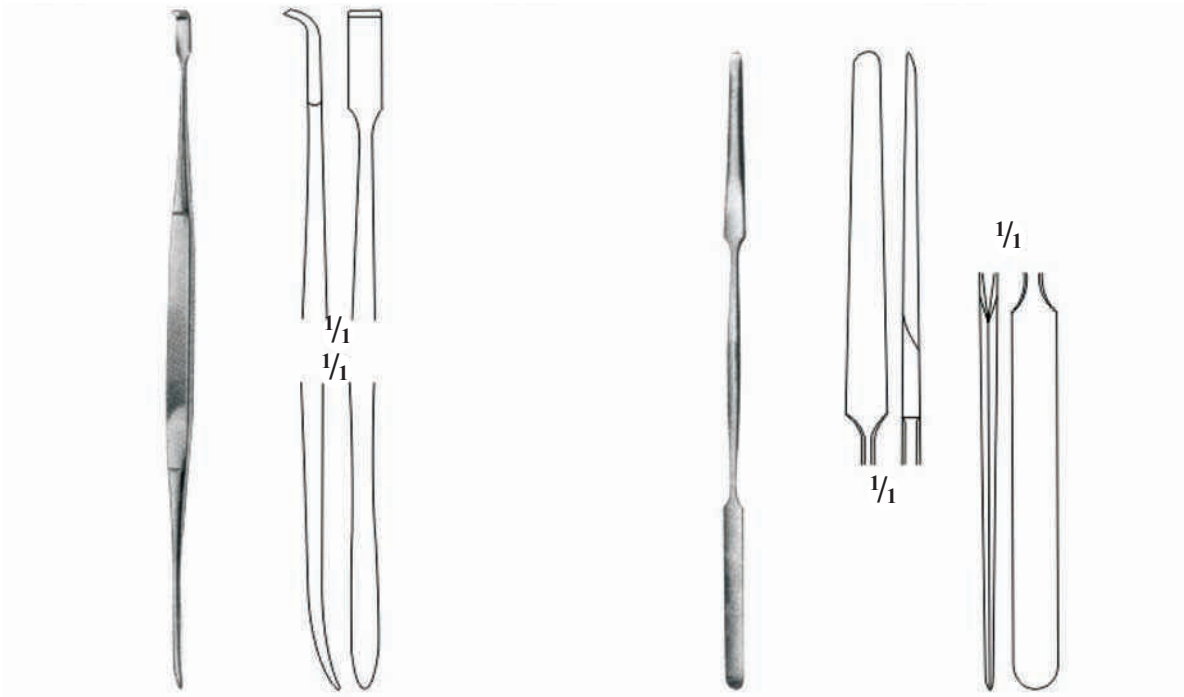

HOWARTH
12-370-215
21.5 cm

KILLIAN
sharp blunt
12-371-215
21.5 cm



COTTLE-NEIVERT
12-372-200
20 cm

CONVERSE
12-373-120
12 cm

MASING
12-374-200
20 cm

COTTLE
12-375-150
15 cm

COTTLE
12-376-150
15 cm

JOSEPH
12-377-160
16 cm

JOSEPH
16 cm

12-378-160
2 mm

12-379-160
5 mm

$\frac{1}{1}$
12-380-160
7 mm

12-381-160
10 mm

JOSEPH
12-382-160
16 cm

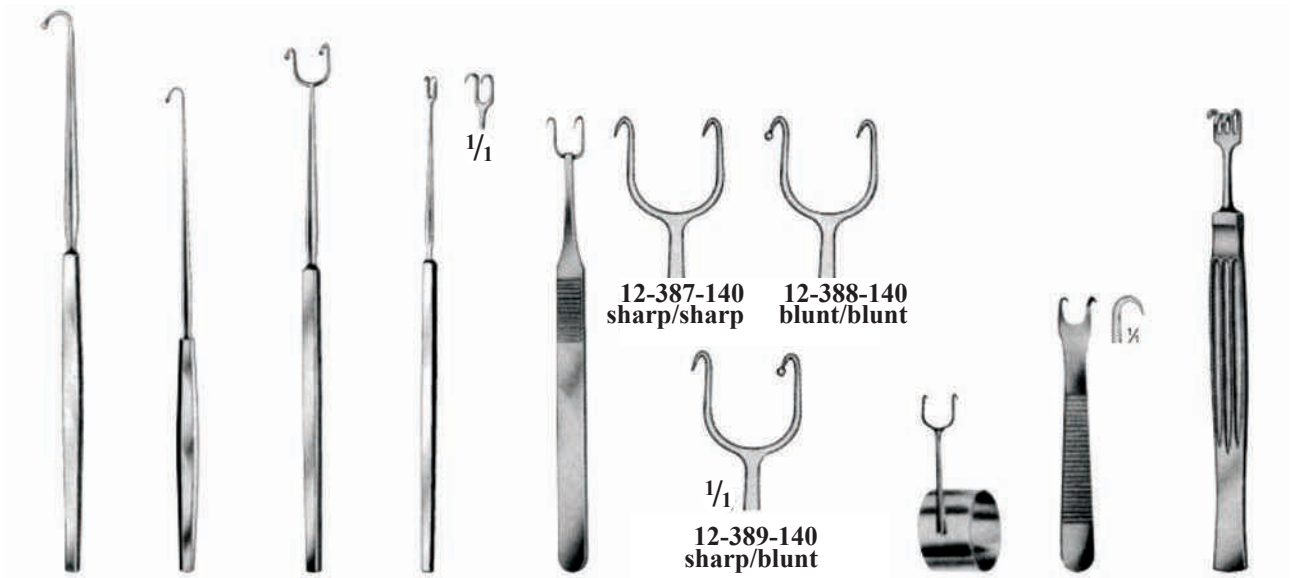

FOMON
12-383-170
17 cm

LANGE
12-384-220
22 cm

FOMON
12-385-160
16 cm

FREER
12-386-150
15 cm

COTTLE
14 cm

12-387-140
sharp/sharp

12-388-140
blunt/blunt

$\frac{1}{1}$
12-389-140
sharp/blunt

COTTLE
12-390-001

KILNER
12-391-001

COTTLE
12-392-140
14 cm



FREER
12-393-160
16 cm
4 mm wide
straight

FREER
12-394-160
16 cm
4 mm wide
curved

FREER
12-395-150
15 cm
4 mm wide

BALLENGER
12-396-155
15.5 cm
6 mm wide

KILLIAN-CLAUS
12-397-170
17 cm
6 mm wide

KILLIAN
12-398-170
17 cm
6 mm wide



MASING
12-399-175
17.5 cm

MASING
12-400-175
17.5 cm

MASING
12-401-175
17.5 cm

MASING
12-402-175
17.5 cm

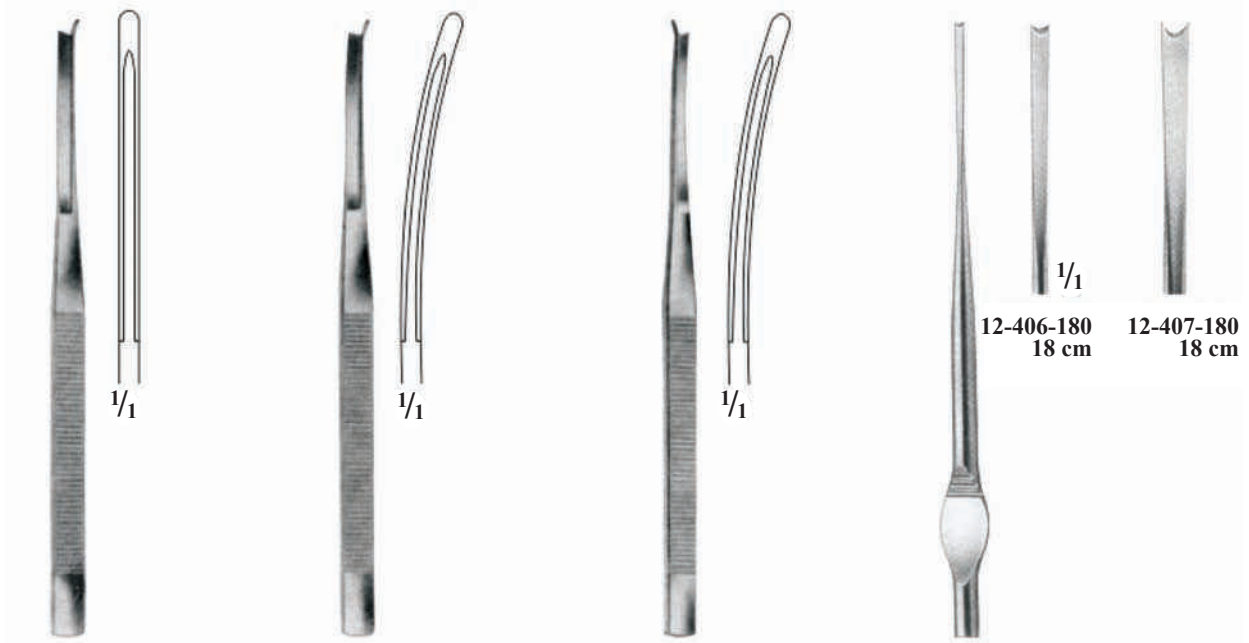

SILVER
12-403-180
18 cm

SILVER
12-404-180
18 cm

SILVER
12-405-180
18 cm

WALTER

12-406-180
18 cm

12-407-180
18 cm

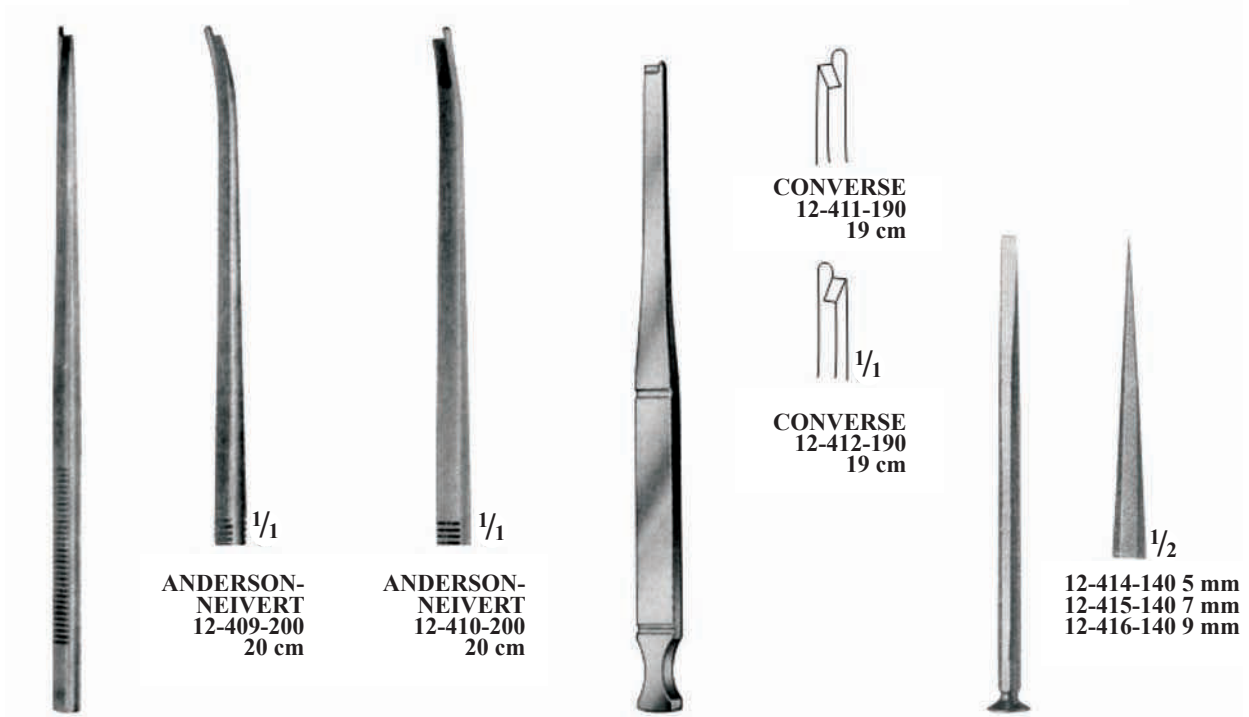

NEIVERT
12-408-200
20 cm

**ANDERSON-
NEIVERT**
12-409-200
20 cm

**ANDERSON-
NEIVERT**
12-410-200
20 cm

CONVERSE

CONVERSE
12-411-190
19 cm

CONVERSE
12-412-190
19 cm

GILLIES
12-413-140
Osteotome
14 cm

12-414-140 5 mm
12-415-140 7 mm
12-416-140 9 mm

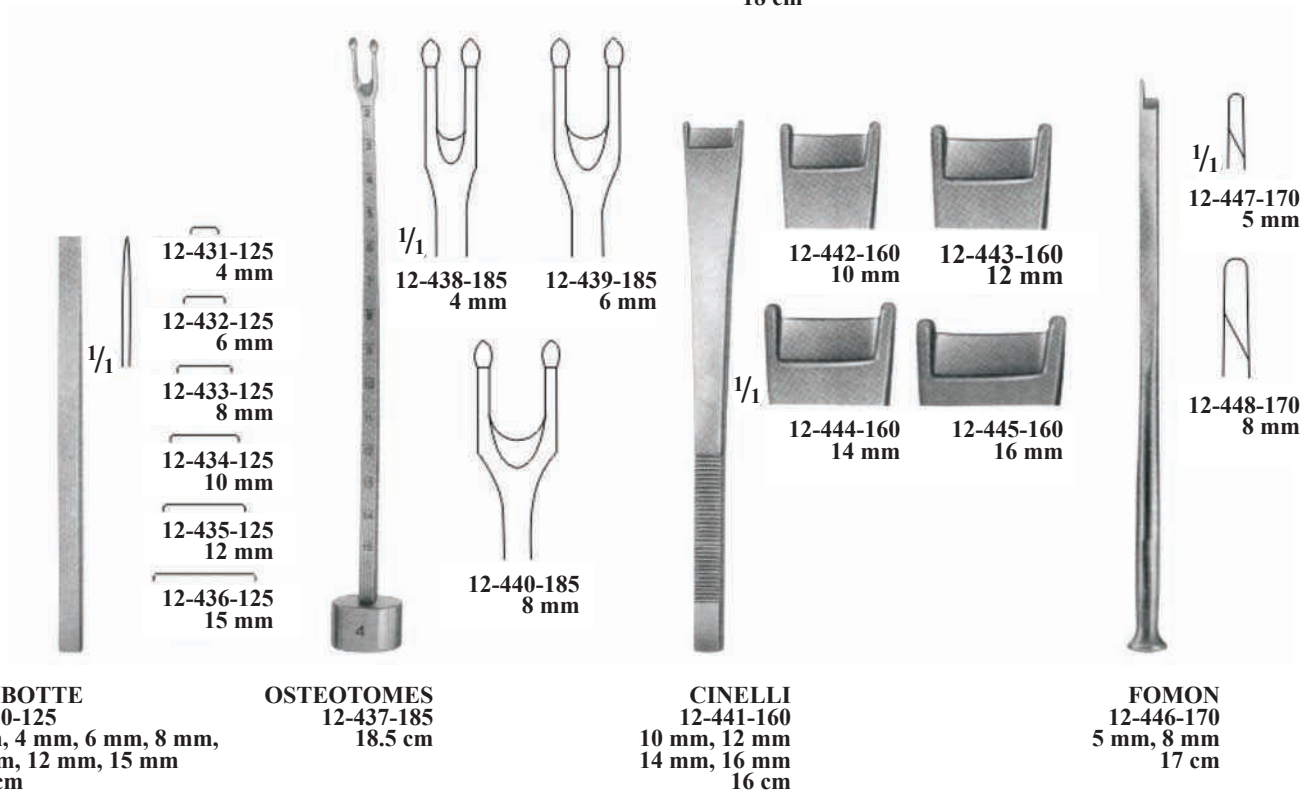
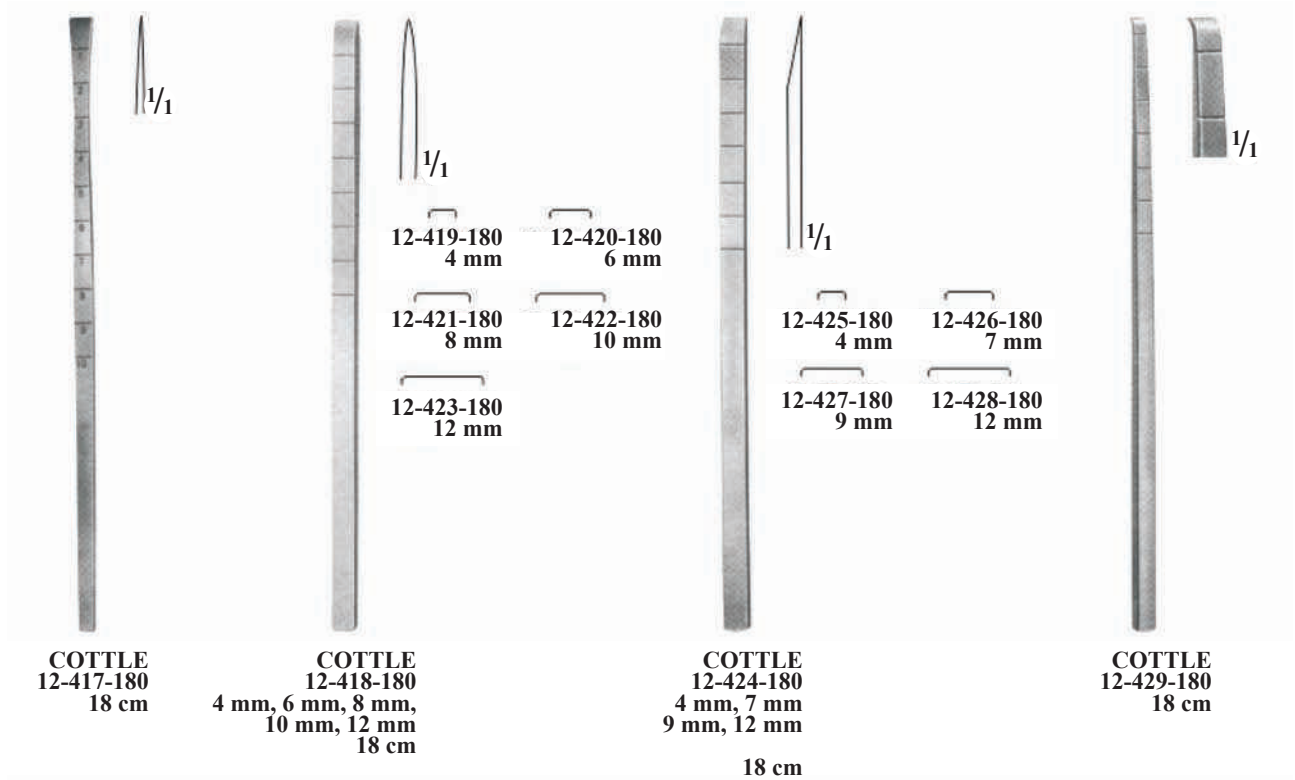

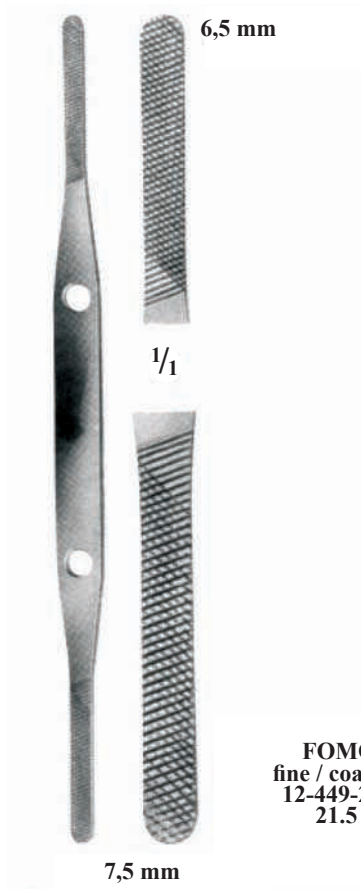

FOMON
fine / coarse
12-449-215
21.5 cm

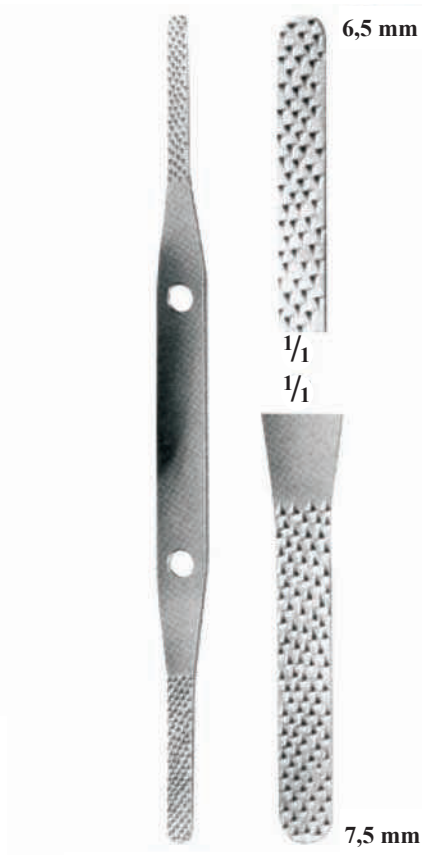

FOMON
fine coarse teeth
12-450-215
21.5 cm

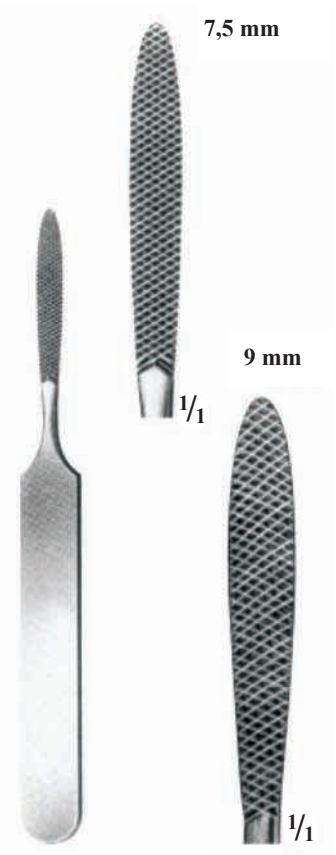

JOSEPH
fine coarse teeth
12-451-165
16.5 cm



12-452-205
Rasps, double
ended, with
tungsten
carbide inserts
20.5 cm

With tungsten
carbide inserts





MILLER-COLBURN
19 cm

MILLER
12-463-185
18.5 cm

AUFRICHT
12-464-185
18.5 cm



LEWIS

MALTZ
12-466-180 Straight
12-466-180 Curved
18 cm

MALTZ
12-467-180
18 cm



ASCH
12-468-230
23 cm

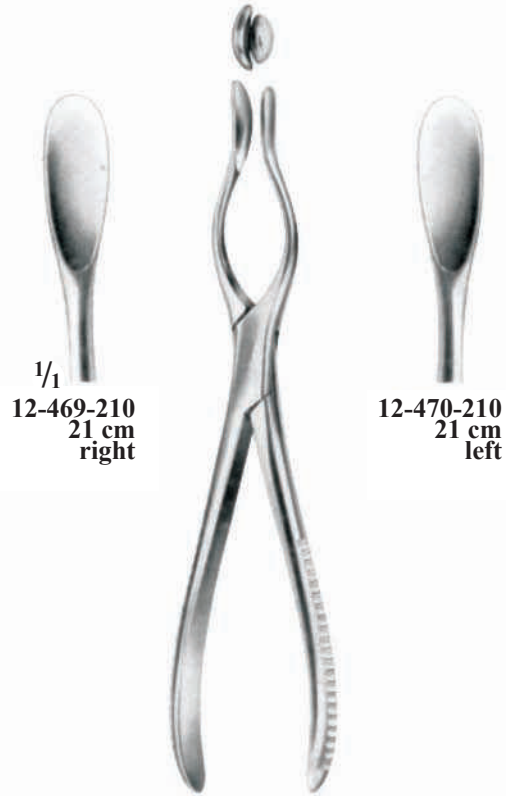

$\frac{1}{1}$
12-469-210
21 cm
right

12-470-210
21 cm
left

WALSHAM



BOIES
12-471-180
18 cm



Cottle Bone



12-472-180
Cottle Cartilage Crusher

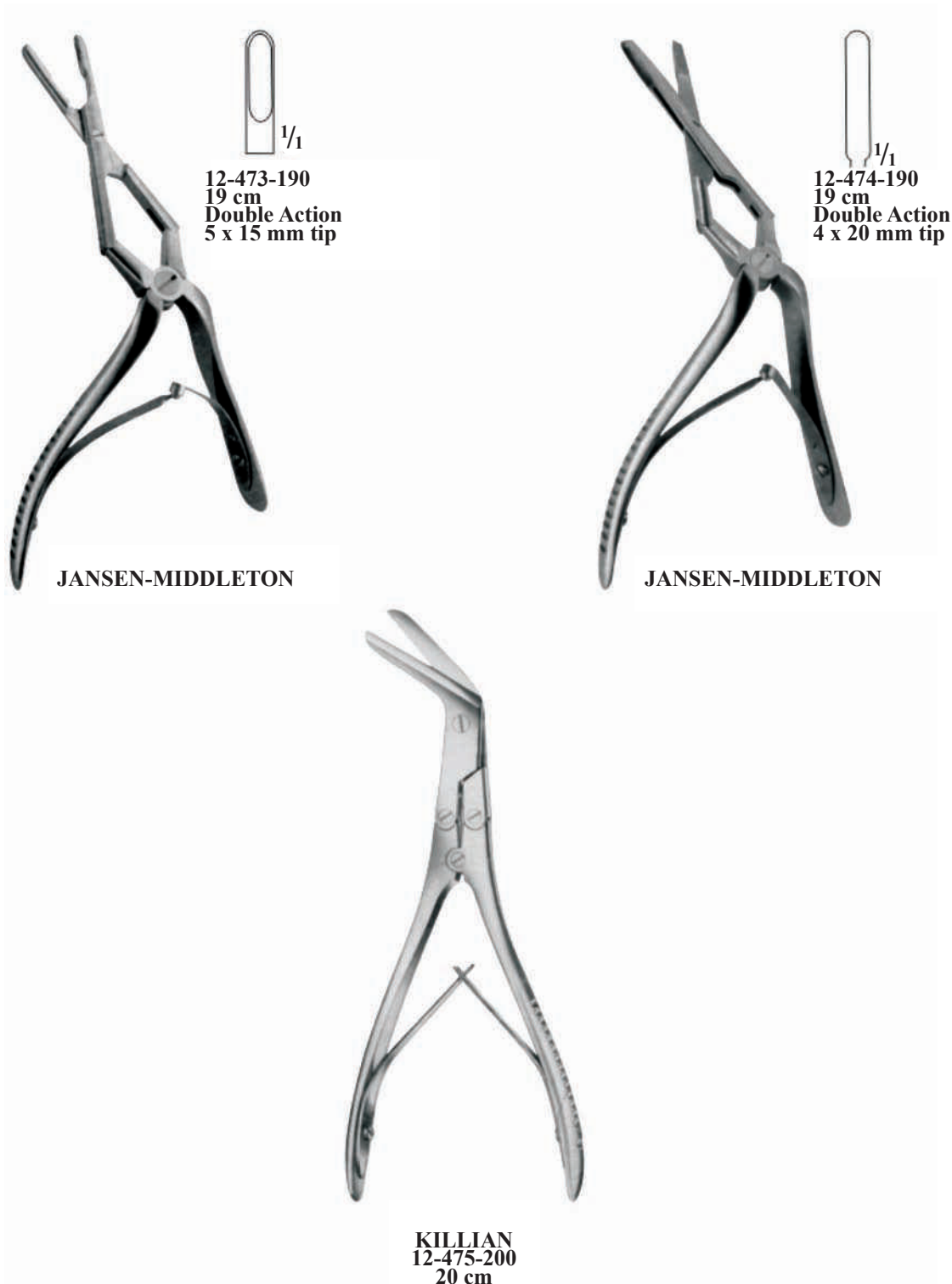



12-476-165
Slightly angled
16.5 cm



12-477-165
Slightly angled 45°
16.5 cm



12-478-149
Slightly angled 90°
14.9 cm



12-479-149
Straight oval jaw
14.9 cm



12-480-165
angled 45°
16.5 cm



12-481-165
Slightly angled
16.5 cm



12-482-245
Slightly angled 45°
24.5 cm

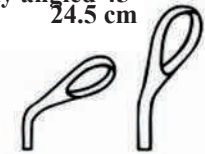

12-483-251
angled 45°
25.1 cm

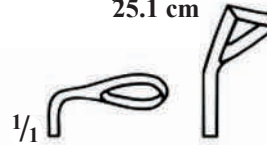

12-484-237
angled 90°
23.7 cm

COAKLEY SINUS

COAKLEY SINUS



12-485-220
22 cm



12-486-222
22.2 cm

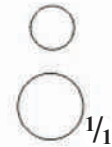

PRATT ENTMOID

FAULKNER EHTMOID



○
2 mm
12-487-001

○
3 mm
12-488-002

○
4 mm
12-489-003

○
5 mm
12-490-004

○
6 mm
12-491-005

○^{1/1}
7 mm
12-492-006

KEYES
12-487-001 – 12-492-006
Dermal Punches

○
2 mm

○
3 mm

○
4 mm

○
5 mm

○
6 mm

○^{1/1}
7 mm

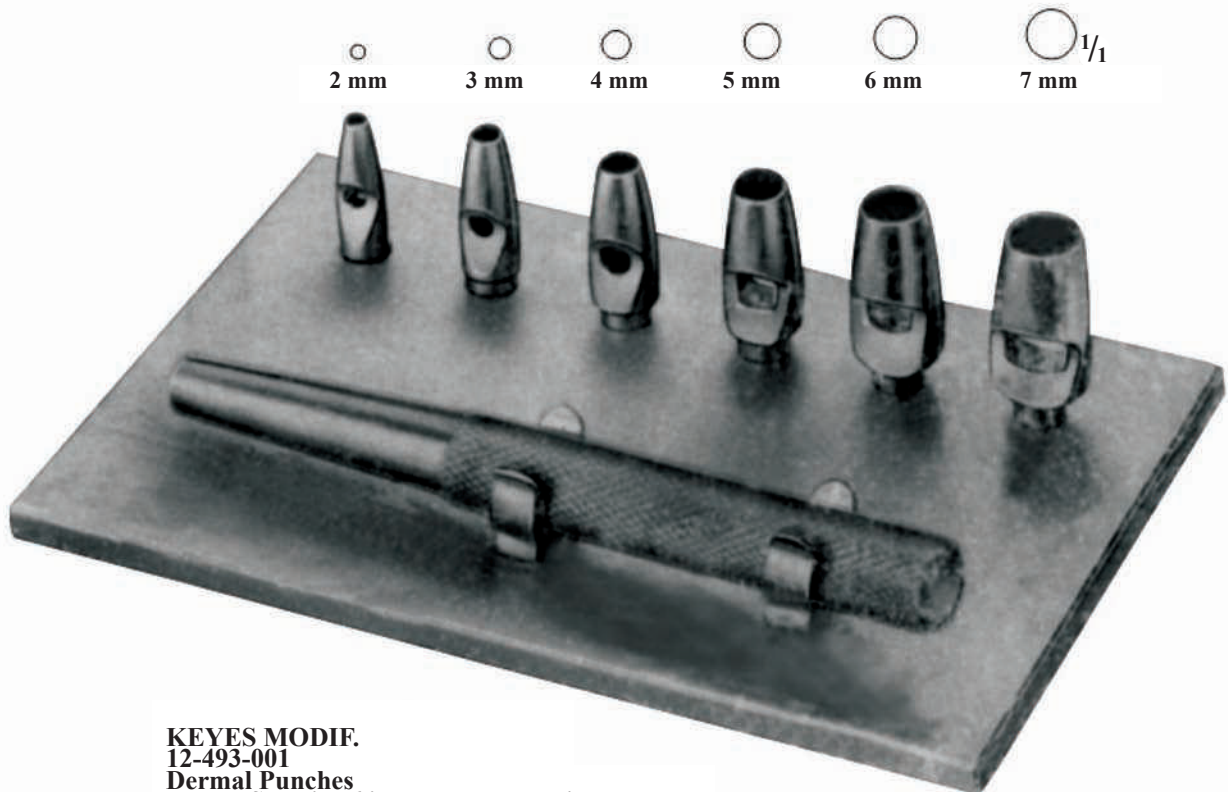

KEYES MODIF.
12-493-001
Dermal Punches
compl. Set with 6 interchangeable tips

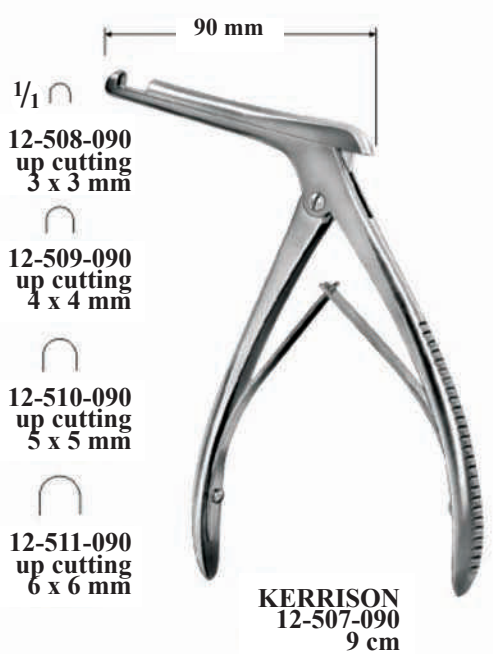
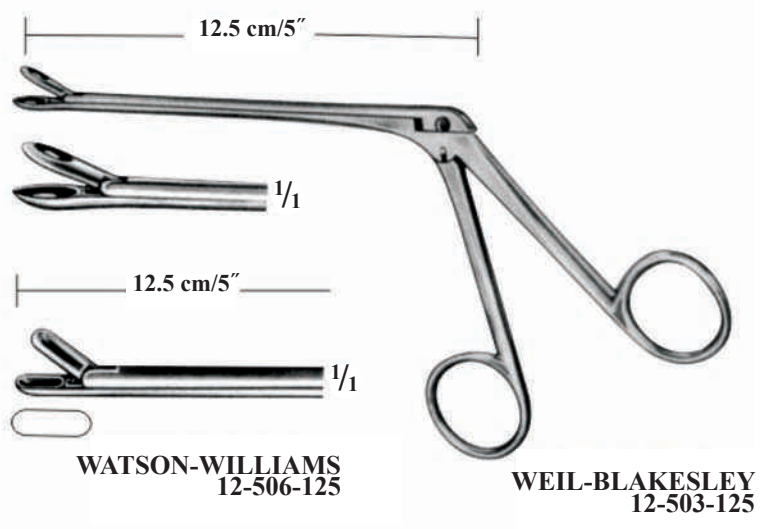
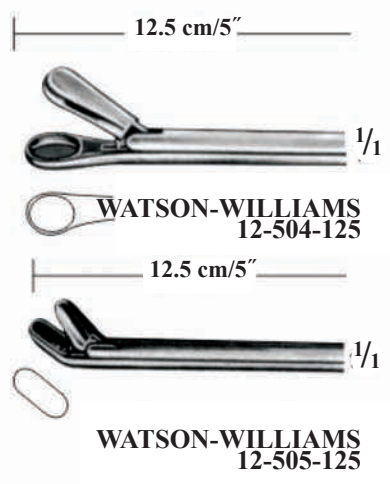
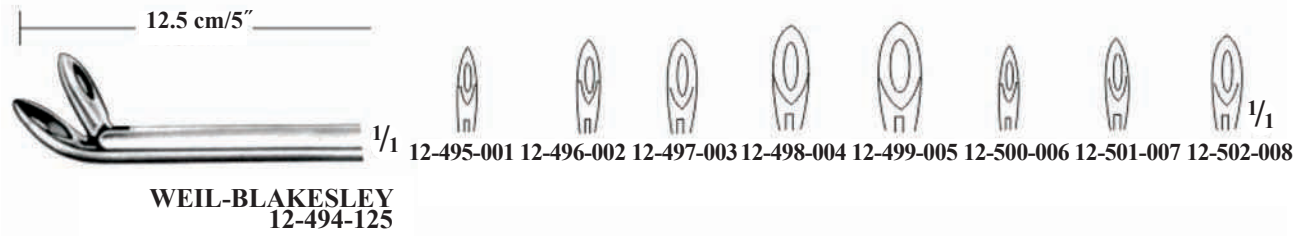

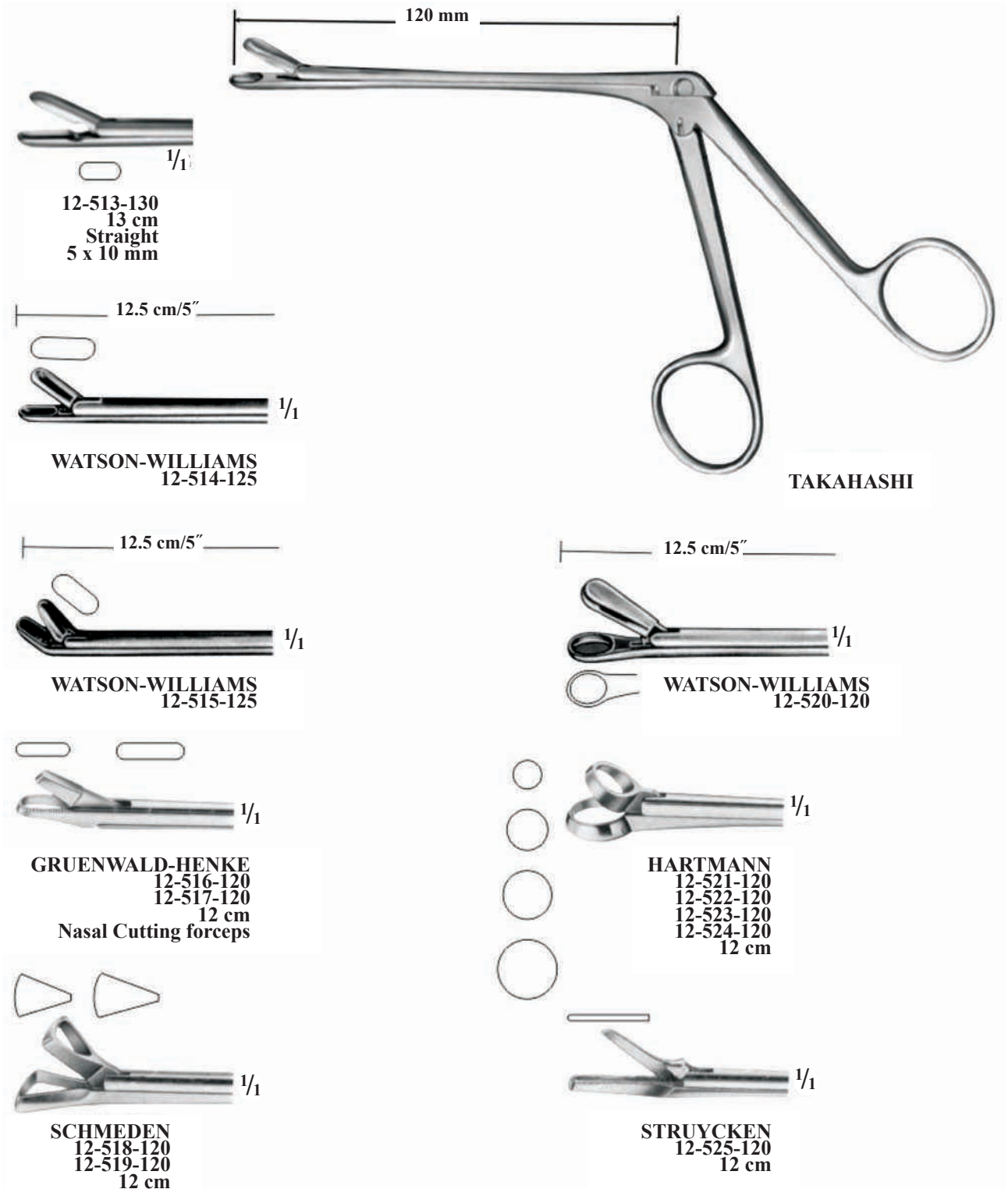



1/1
12-527-145 12-528-145
14.5 cm 14.5 cm
serrated 28 mm serrated 32 mm

TOBOLD
12-526-145
14.5 cm

WEIDER TONGUE DEPRESSOR TONGUE DEPRESSOR
12-529-145 12-530-145
14.5 cm 14.5 cm



BUCHWALD
12-531-180
18 cm

BRUENINGS
12-532-190
19 cm

FRENZEL
12-533-165
16.5 cm

M-SCHMIDT
12-534-190
19 cm



FERGUSON-ACKLAND
12-535-145
14.5 cm

DENHARDT
12-536-125
12.5 cm
Mouth Gag
with silicon inserts,
interchangeable

ROSER-KONIG
12-537-160
16 cm
Mout Gag

DOYEN-COLLIN
12-538-120 12 cm
12-539-140 14 cm
Mout Gag

MOLT
12-540-100
10 cm
Mouth Gag
for children

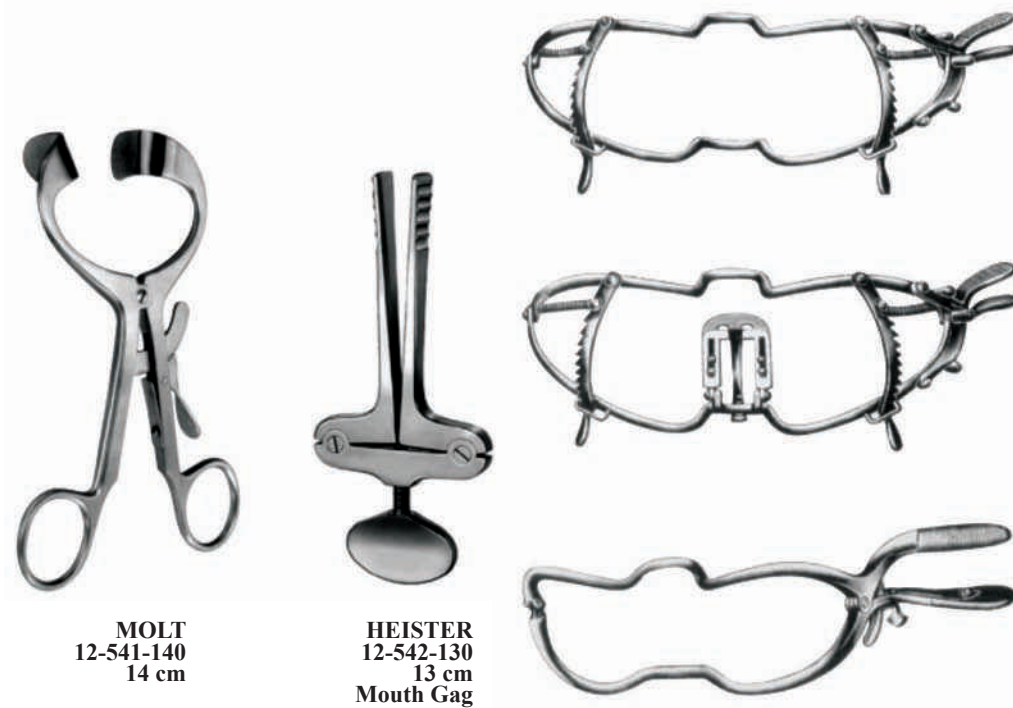

MOLT
12-541-140
14 cm

HEISTER
12-542-130
13 cm
Mouth Gag

WHITEHEAD
12-543-090 9 cm
12-544-110 11 cm
12-545-130 13 cm
12-546-150 15 cm
Mouth Gag

WHITEHEAD
12-547-110 11 cm
12-548-130 13 cm
12-549-150 15 cm
Mouth Gag
with tongue depressor

WHITEHEAD-JENNINGS
12-550-090 9 cm
12-551-110 11 cm
12-552-130 13 cm
12-553-150 15 cm
Mouth Gag



DAVIS-BOYLE
12-554-001
Complete Set
Double Bite-Lift Side
Gag only left side



12-555-001



12-556-002



12-557-003



12-558-004



12-559-005

DAVIS-BOYLE
12-555-001 19 x 25 mm
12-556-002 25 x 62 mm
12-557-003 25 x 75 mm
12-558-004 25 x 92 mm
12-559-005 25 x 108 mm
Tongue Blades only



12-560-001
Gag Only

MCIVOR



12-561-001
Complete Set
with 3 Blades



MCIVOR
blade



MODELL WURZBURG
12-562-001 66 x 28 mm
12-563-002 75 x 32 mm
12-564-003 83 x 34 mm
12-565-004 93 x 37 mm
12-566-005 100 x 38 mm
Tongue Blades only



RUSSEL-DAVIS

12-567-001 29 x 67 mm
 12-568-002 33 x 75 mm
 12-569-003 38 x 85 mm
 12-570-004 40 x 92 mm
 12-571-005 46 x 100 mm



12-567-001 1/1



12-568-002 1/1



12-569-003 1/1



12-570-004 1/1



12-571-005 1/1



RUSSEL-DAVIS

12-572-001 18 x 57 mm
 12-573-002 22 x 67 mm
 12-574-003 25 x 75 mm



12-572-001 1/1



12-573-002 1/1



12-574-003 1/1

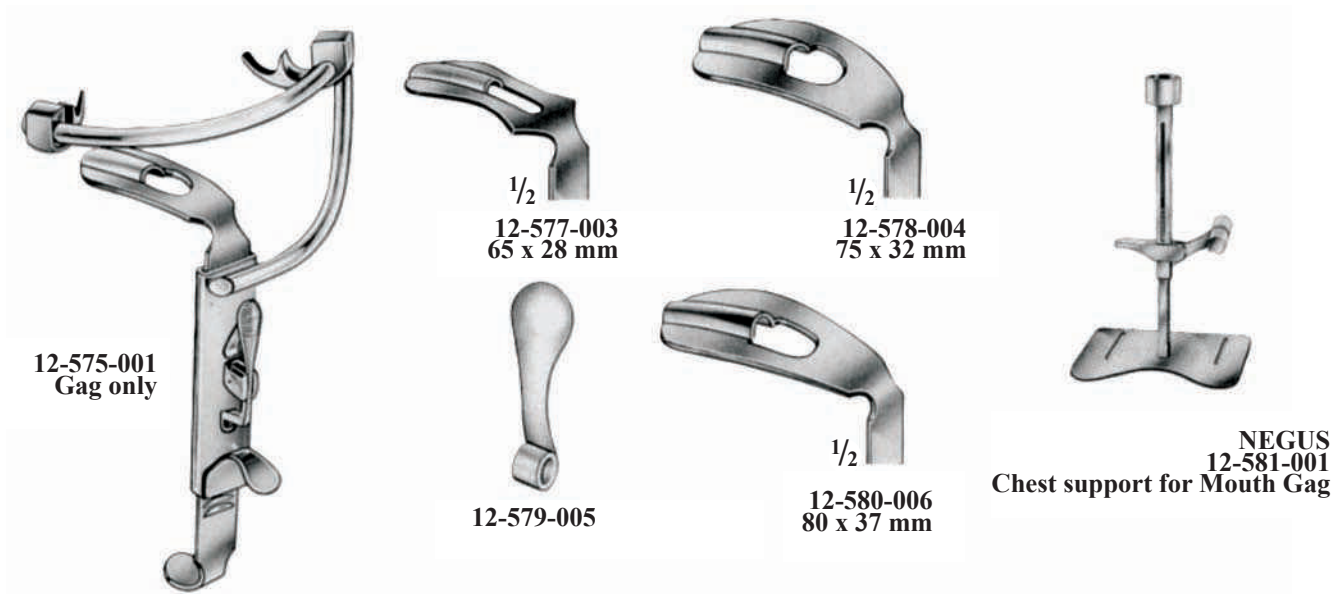

KILNER-DOUGHTY
12-576-002
complete

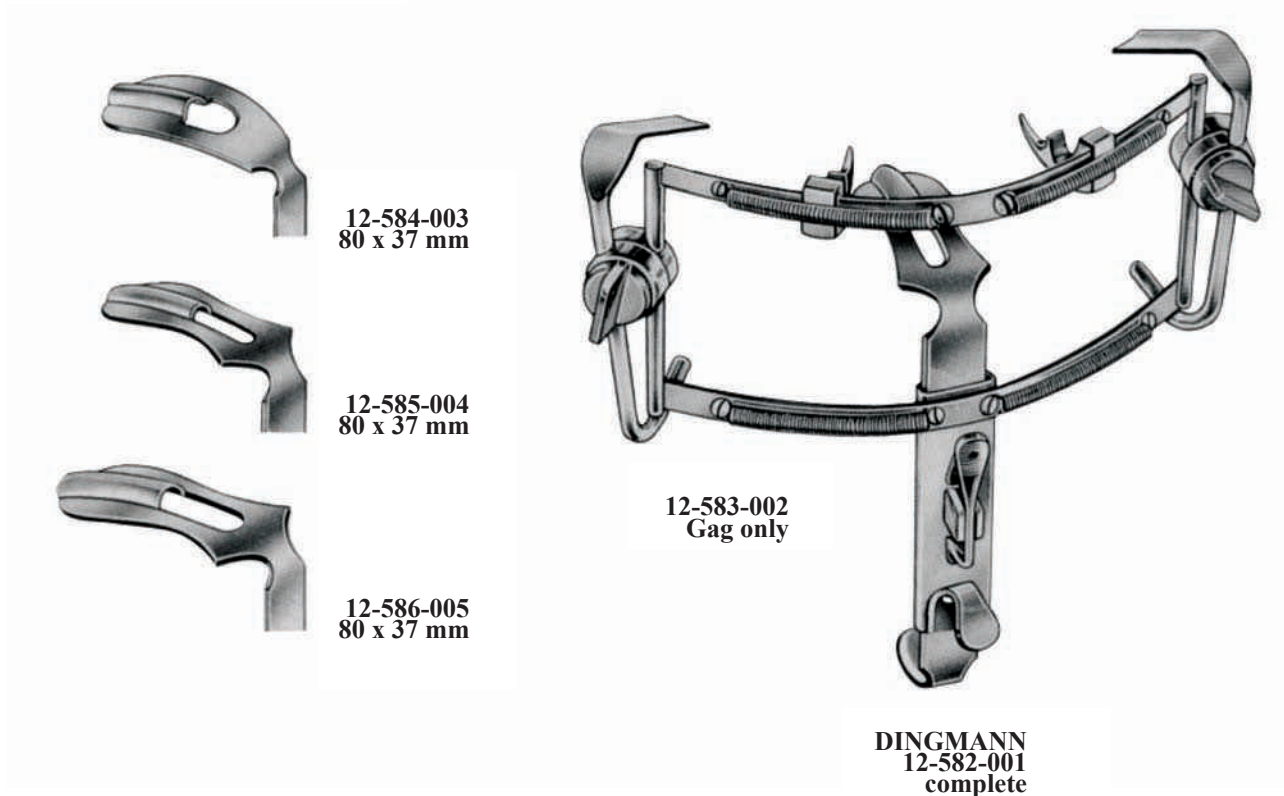



SIMPLEX
12-587-110
11 cm



STERNBERG
12-588-120 12 cm
12-589-140 14 cm
12-590-160 16 cm



HARTMANN
12-591-150
15 cm



UNIV. MINNESOTA
12-592-140
14 cm



12-593-190
19 cm



ROUX
12-594-150
15 cm

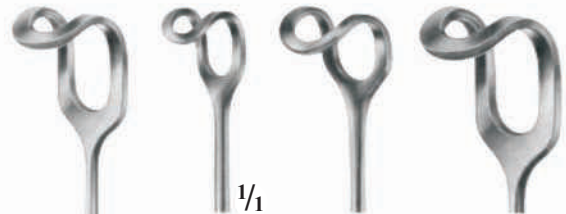

12-595-200 15 x 15 mm
12-596-210 20 x 22 mm
12-597-230 26 x 30 mm



MIDDELDORPF
12-595-200 20 cm
12-596-210 21 cm
12-597-230 23 cm

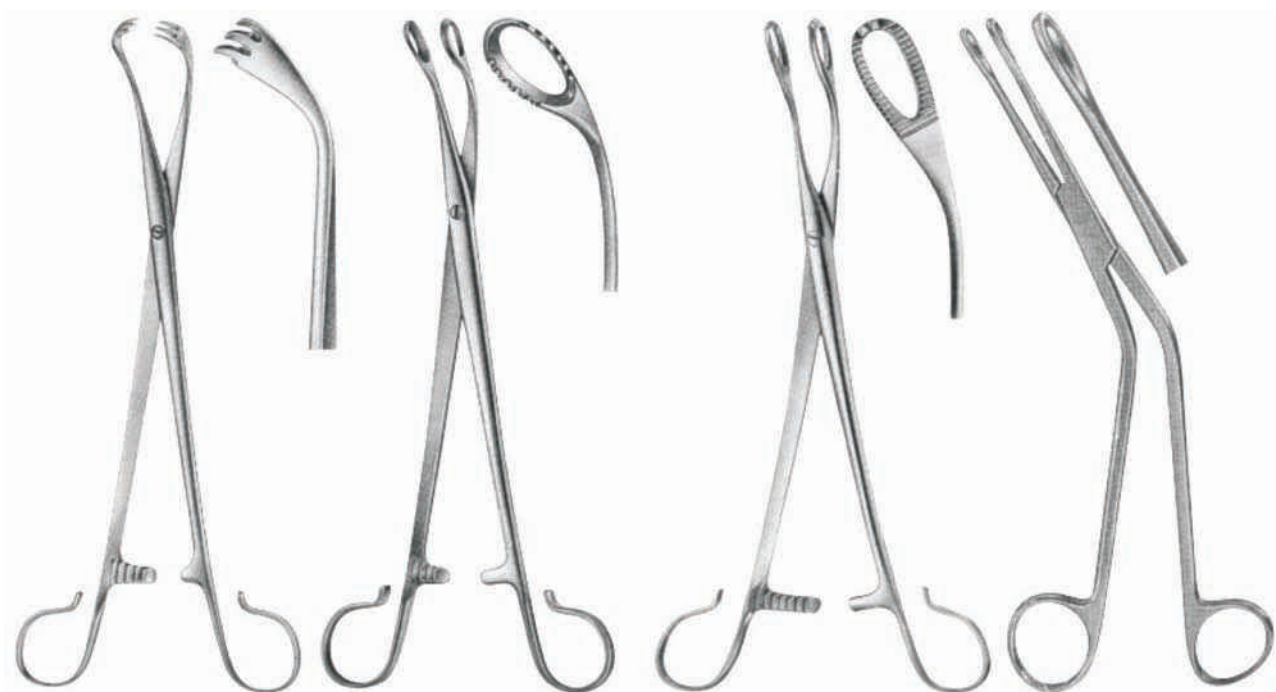

MARSCHIK-KRONE
12-598-205
20.5 cm

ABRAHAM
12-599-205
20.5 cm

BLOHMKE
12-600-205
20.5 cm

BLOHMKE
12-601-205
20.5 cm

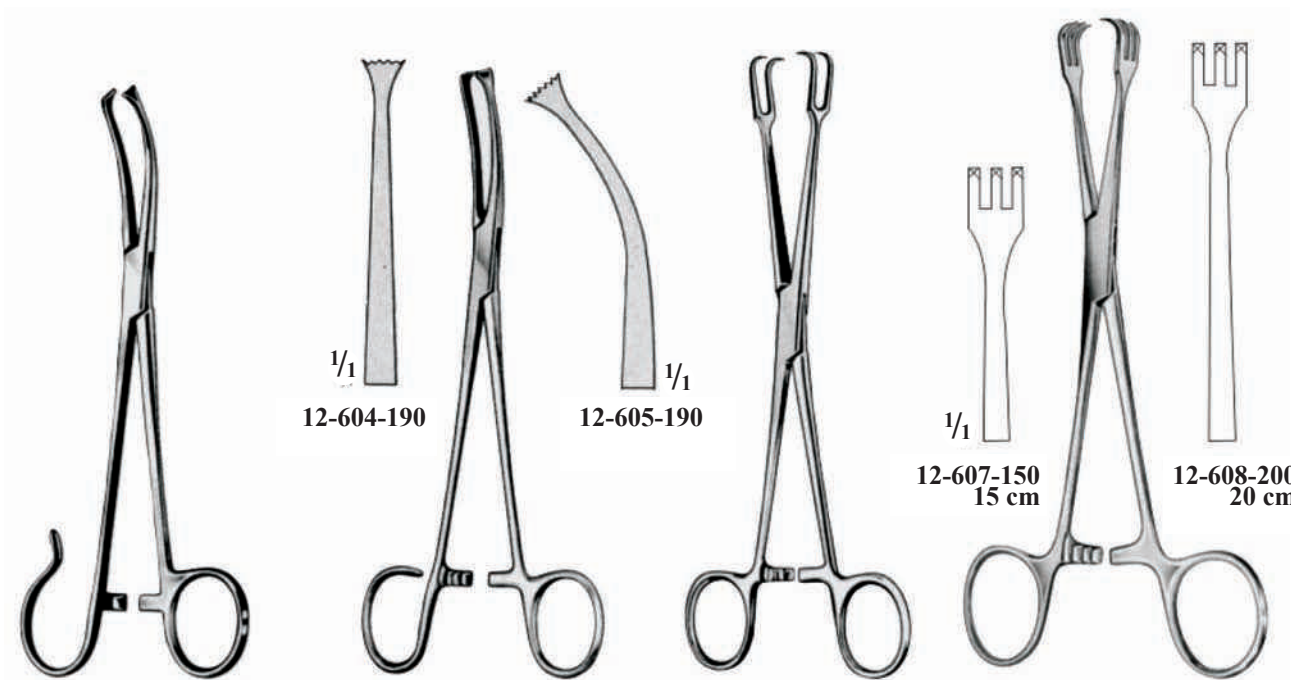

WHITE
12-602-210 18 cm
12-603-230 23 cm

COLVER
19 cm

MUSEUX
12-606-190
19 cm

LAHEY

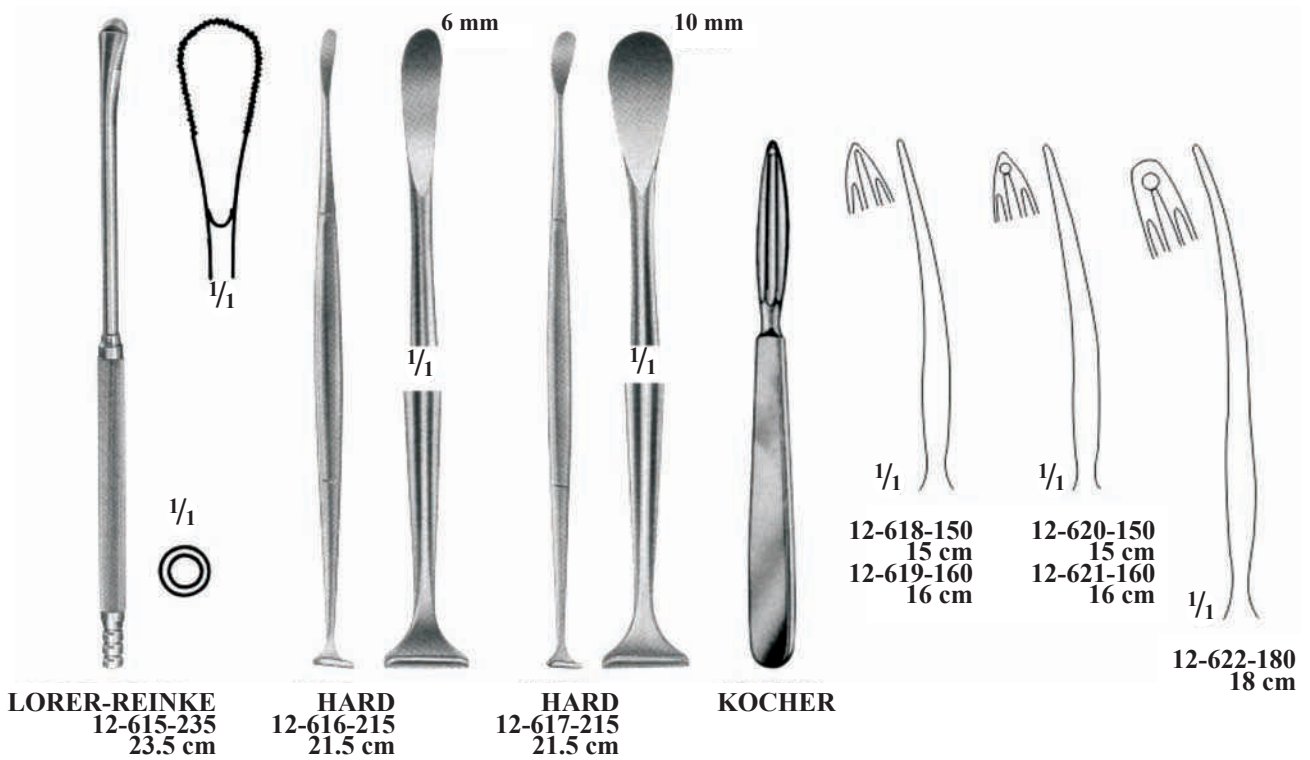
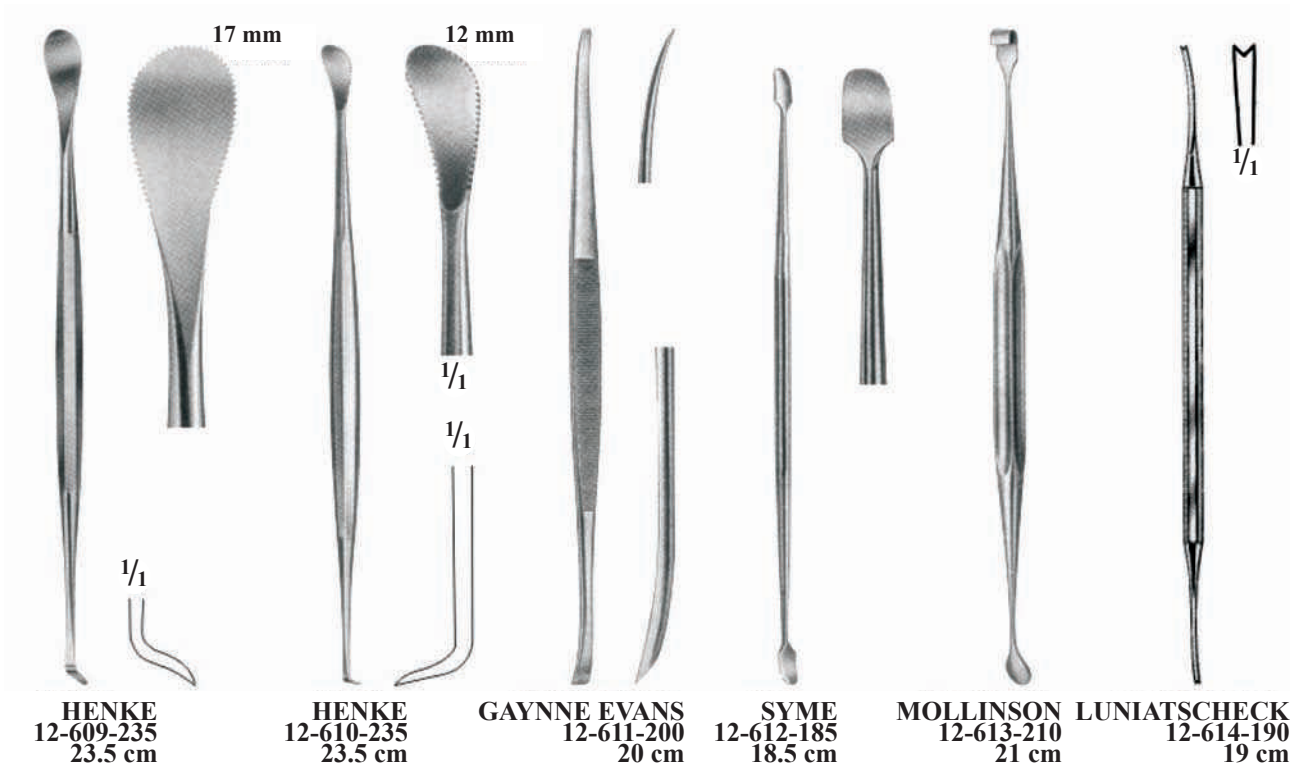

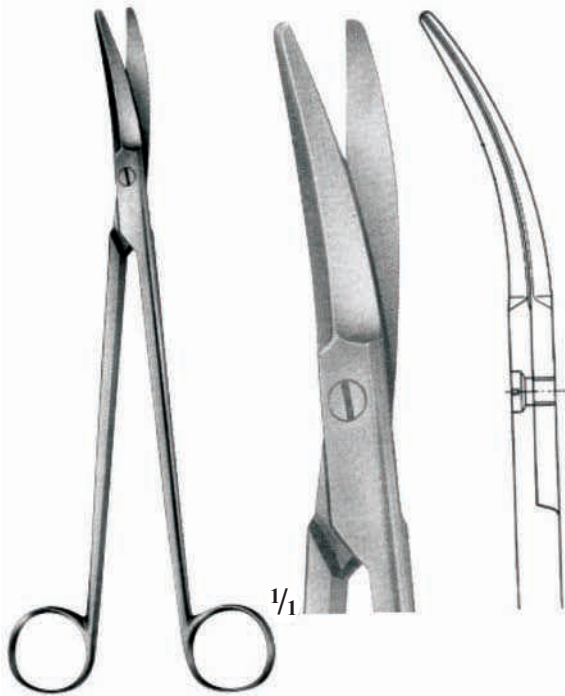

BOETTCHER
12-623-180
18 cm



DEAN
12-624-170
17 cm

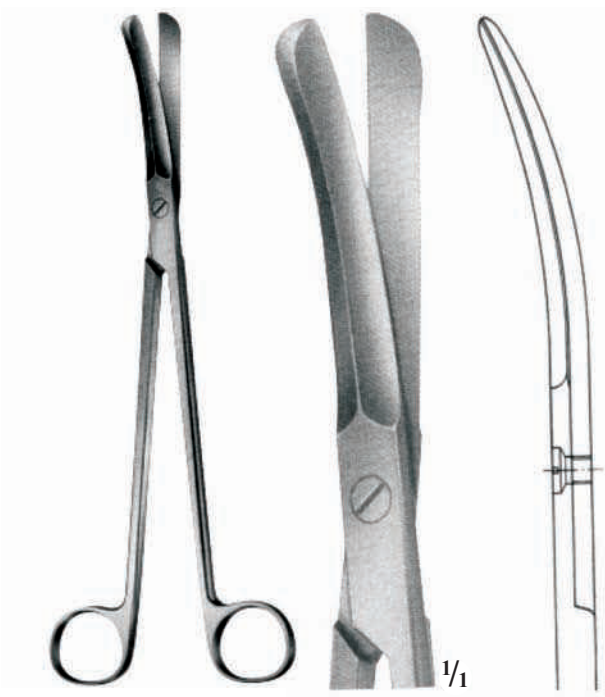

GOOD
12-625-195
19.5 cm



SCHWECKENDIEK
12-626-195
19.5 cm

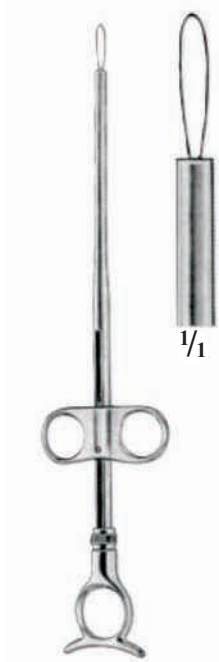

EVES
12-627-280
28 cm

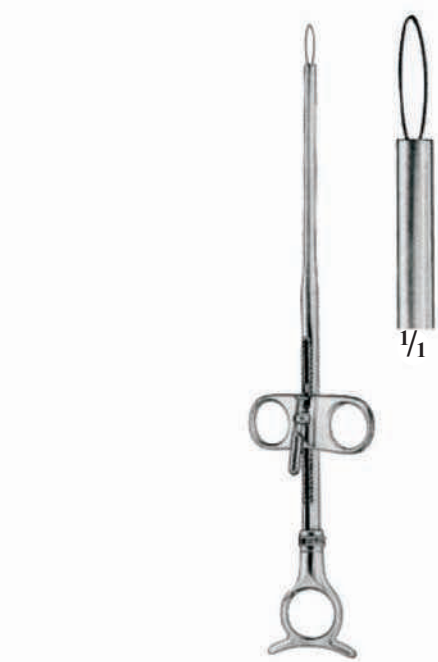

EVES
12-628-280
28 cm

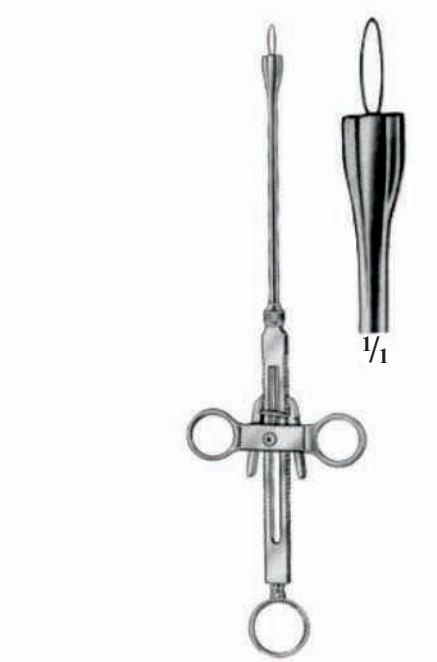

BRUENINGS
12-629-280
28 cm

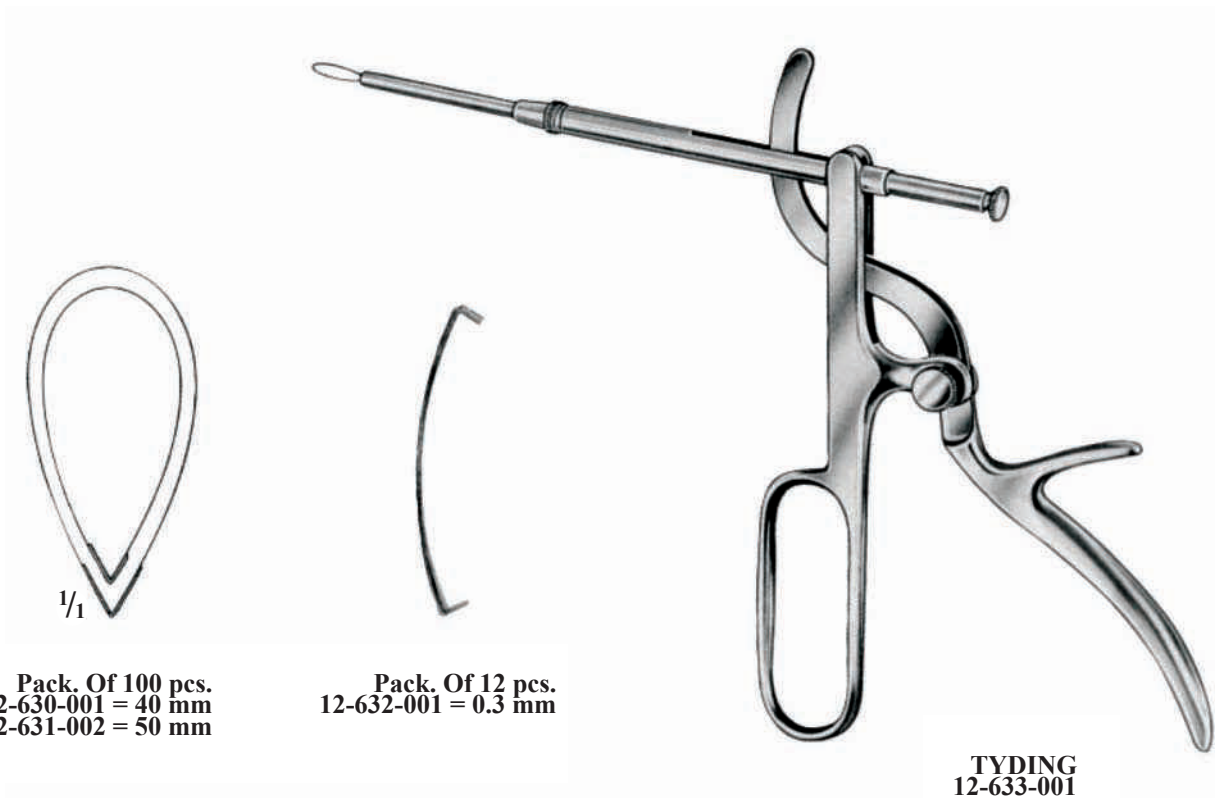

Pack. Of 100 pcs.
12-630-001 = 40 mm
12-631-002 = 50 mm

Pack. Of 12 pcs.
12-632-001 = 0.3 mm

TYDING
12-633-001



1/1

12-634-001

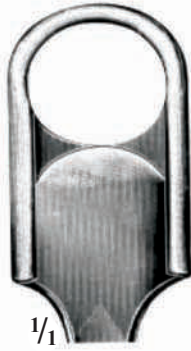

1/1

12-635-002



1/1

12-636-003



SLUDER-BALLENGER
12-634-001 to 12-636-003
Complete, with 3 tips fig. 1-3



RODER
12-637-265
26.5 cm



HOFER
12-638-240
24 cm



NAGER
12-639-230
23 cm



LOVE
12-640-180 18 cm
12-641-200 20 cm
12-642-220 22 cm



HASLINGER
12-643-170
17 cm



MATIN
12-644-170
17 cm

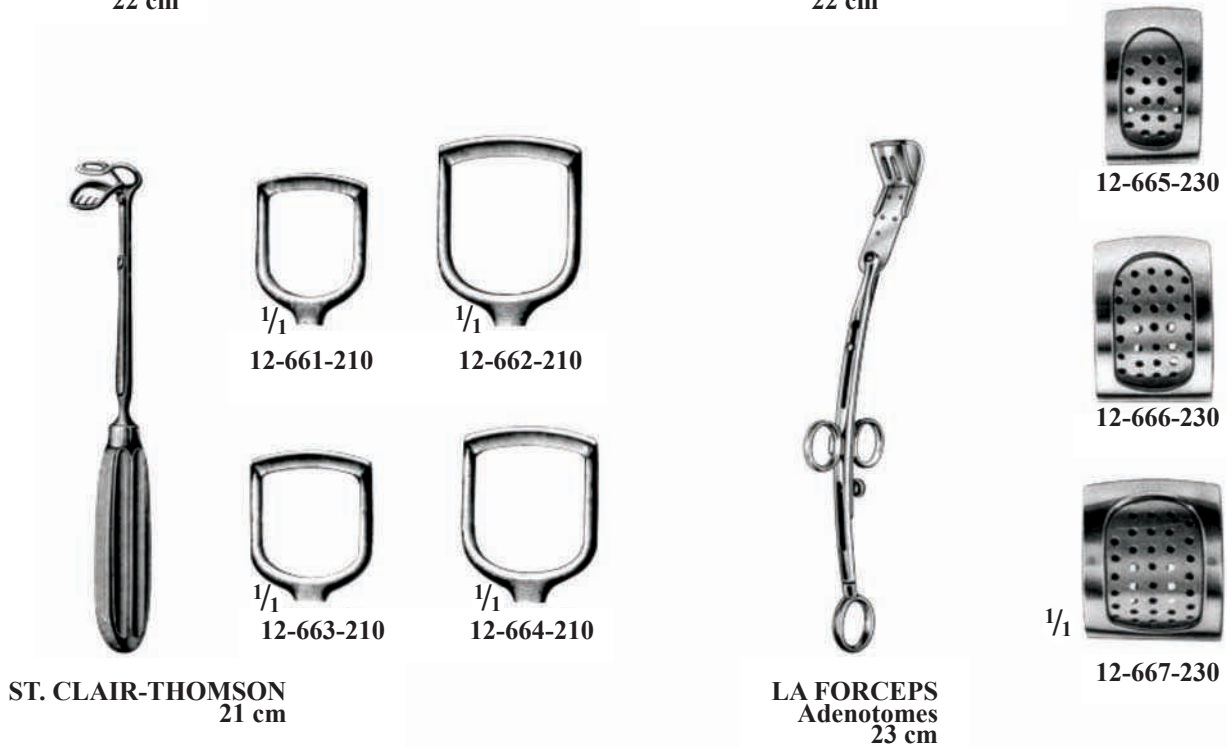
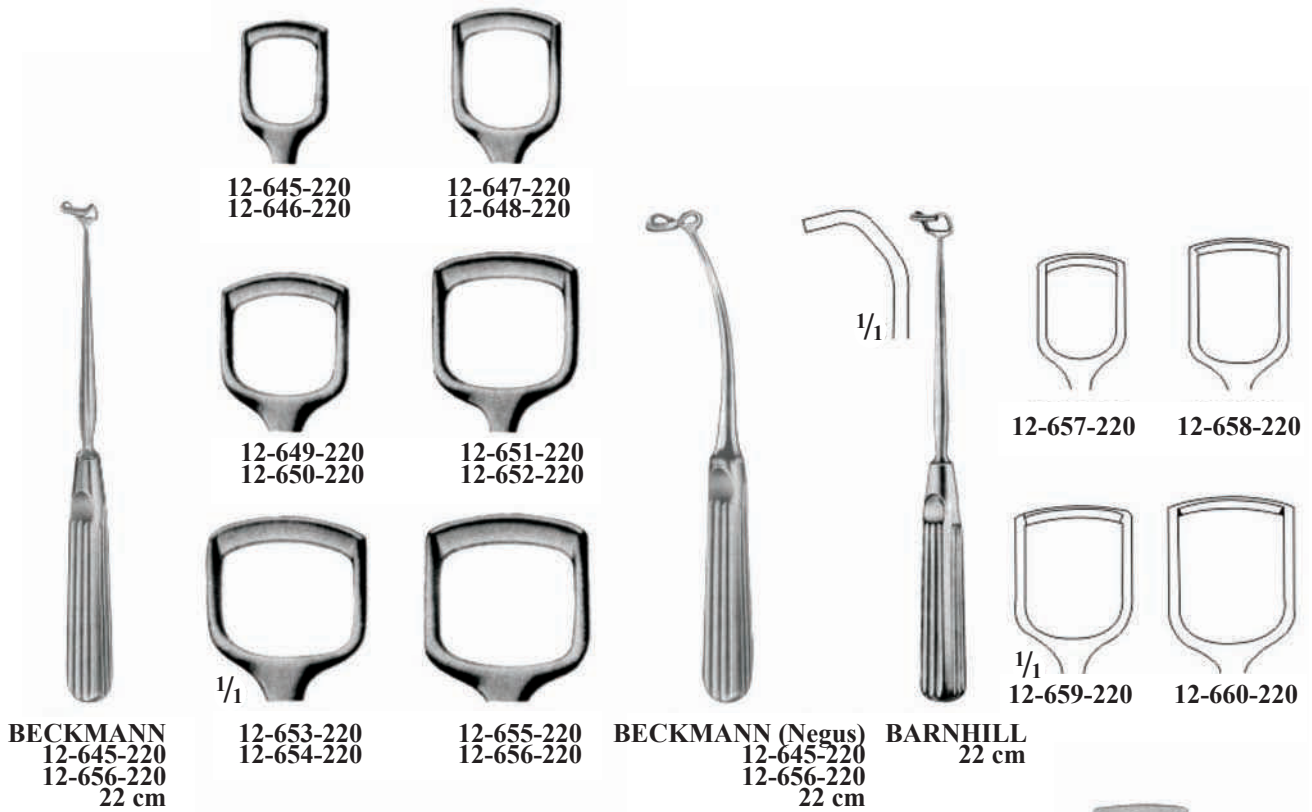

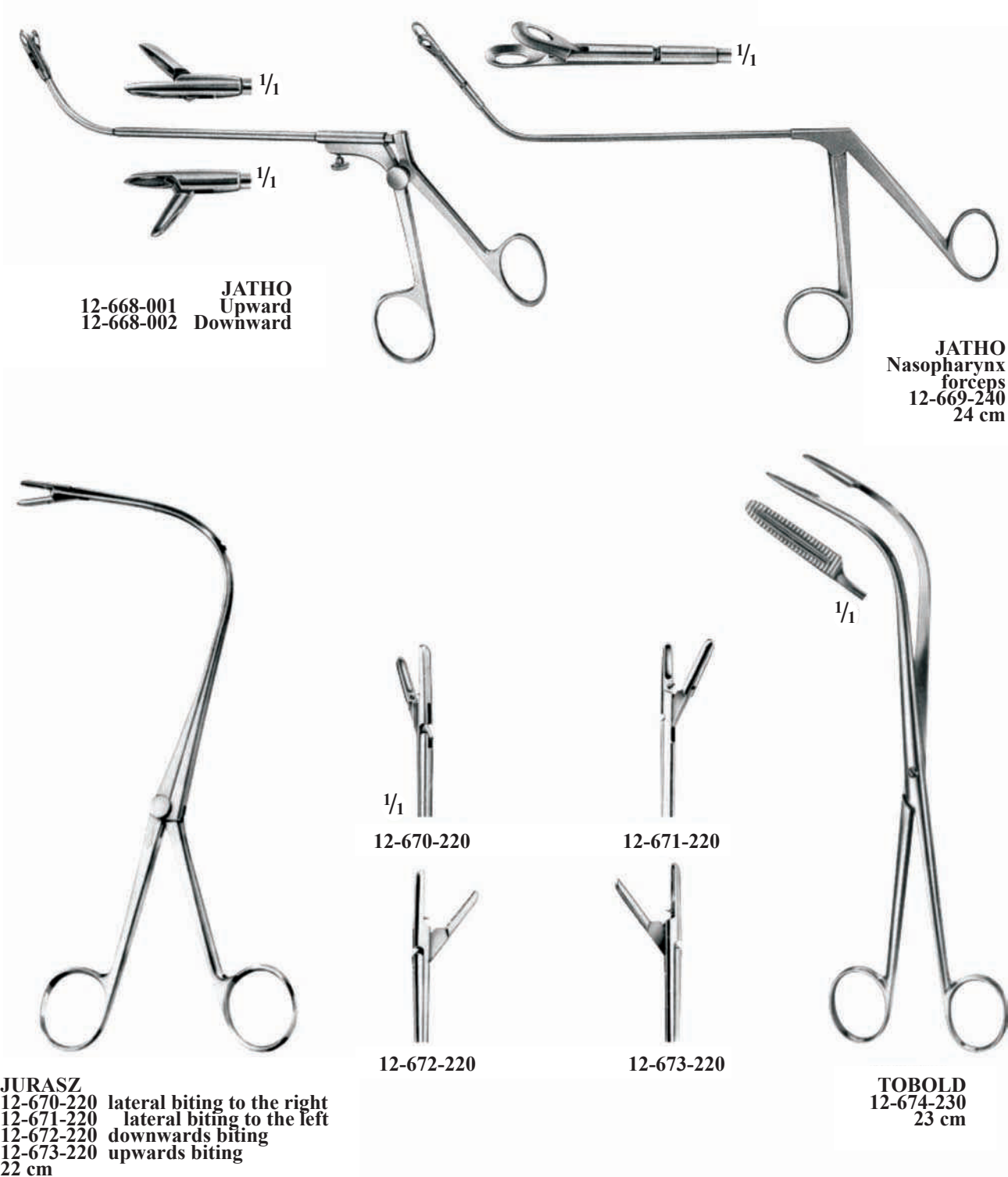

12-668-001 **JATHO**
12-668-002 Upward
Downward

JATHO
Nasopharynx
forceps
12-669-240
24 cm

JURASZ
12-670-220 lateral biting to the right
12-671-220 lateral biting to the left
12-672-220 downwards biting
12-673-220 upwards biting
22 cm

1/1
12-670-220

12-671-220

12-672-220

12-673-220

TOBOLD
12-674-230
23 cm



12-675-001
00 8 mm

12-676-002
0 10 mm

12-677-003
1 12 mm

12-678-004
2 14 mm

12-679-005
3 16 mm

12-680-006
4 18 mm

12-681-007
5 20 mm

12-682-008
6 22 mm

12-683-009
7 24 mm

12-684-010
8 26 mm

**LARYNGEL
MIRROR
with Handle**

MIRROR
12-685-150
15 cm

Handle for
All Sizes
12-686-150
15 cm

12-687-001
1- Electric mirror handle with light
2- With three spare battery



BRÜNINGS
12-688-001
Universal handle, with lever
on the left, for use with
tubes
12-693-200 to
12-698-500



AESCULAP
12-689-001
Universal handle, with lever
on the right, for use with
tubes
12-693-200 to
12-698-500



HUBER
12-690-001
Universal handle, with lever
on the right, for use with
tubes
12-693-200 to
12-698-500



BRÜNINGS
12-691-200
20 cm
Curved Tube with Stylet
12-692-200
20 cm
Curved Tube with Stylet



BRÜNINGS
12-693-200 20 cm
12-694-250 25 cm
12-695-300 30 cm
12-696-350 35 cm
12-697-400 40 cm
12-698-500 50 cm
Straight Tubes with
Stylet, stiff

12-699-001



1/1

12-700-001



1/1

KAHLER
12-701-001



1/1

EICKEN
12-702-001



1/1

FRAENKEL
12-703-001



1/1

FRAENKEL
12-704-001



1/1

SCHEINMANN
12-705-001



1/1

BRÜNINGS
12-706-001 Ø 2 mm
12-707-002 Ø 3 mm
12-708-003 Ø 4 mm

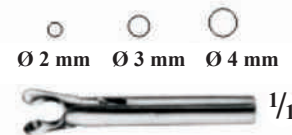

1/1

BRÜNINGS
12-709-001



1/1

LANGE
12-710-001



1/1

LANGE
12-711-001



1/1

KRAUSE
12-712-001
12-713-002



1/1

SCHEINMANN
12-714-001



1/1

SCHEINMANN
12-715-001



1/1

CORDES
12-716-001



1/1

CORDES
12-717-001



1/1

ROSENBERG
12-718-001



1/1

STRUYCKEN
12-719-001



1/1



12-720-001
Chest Support and Laryngoscope Holder,
complete, for adults and children



12-721-180
18 cm
Operating Laryngoscope,
for adults, large



12-722-180
18 cm
Operating Laryngoscope,
for adults, medium



12-723-130
13 cm
Operating Laryngoscope,
for children



1/1

12-724-180
18 cm
Operating Laryngoscope,
for adults, small



12-725-001
Light guide for use laryngoscopes



12-726-002
Light guide for use laryngoscopes





FERGUSSON
 12-727-180 Ø 2.0 mm, 6 F.G.
 12-728-180 Ø 2.0 mm, 7-8 F.G.
 12-729-180 Ø 3.0 mm, 9 F.G.
 12-730-180 Ø 4.0 mm, 12 F.G.
 12-731-180 Ø 5.0 mm, 15 F.G.
 18 cm

PLESTER
 12-732-195 Ø 1.5 mm, 4-5 F.G.
 12-733-195 Ø 2.0 mm, 6 F.G.
 12-734-195 Ø 2.5 mm, 7-8 F.G.
 12-735-195 Ø 3.0 mm, 9 F.G.
 19.5 cm

NASAL SUCTION TUBES
 12-736-160 Ø 5 mm
 16 cm

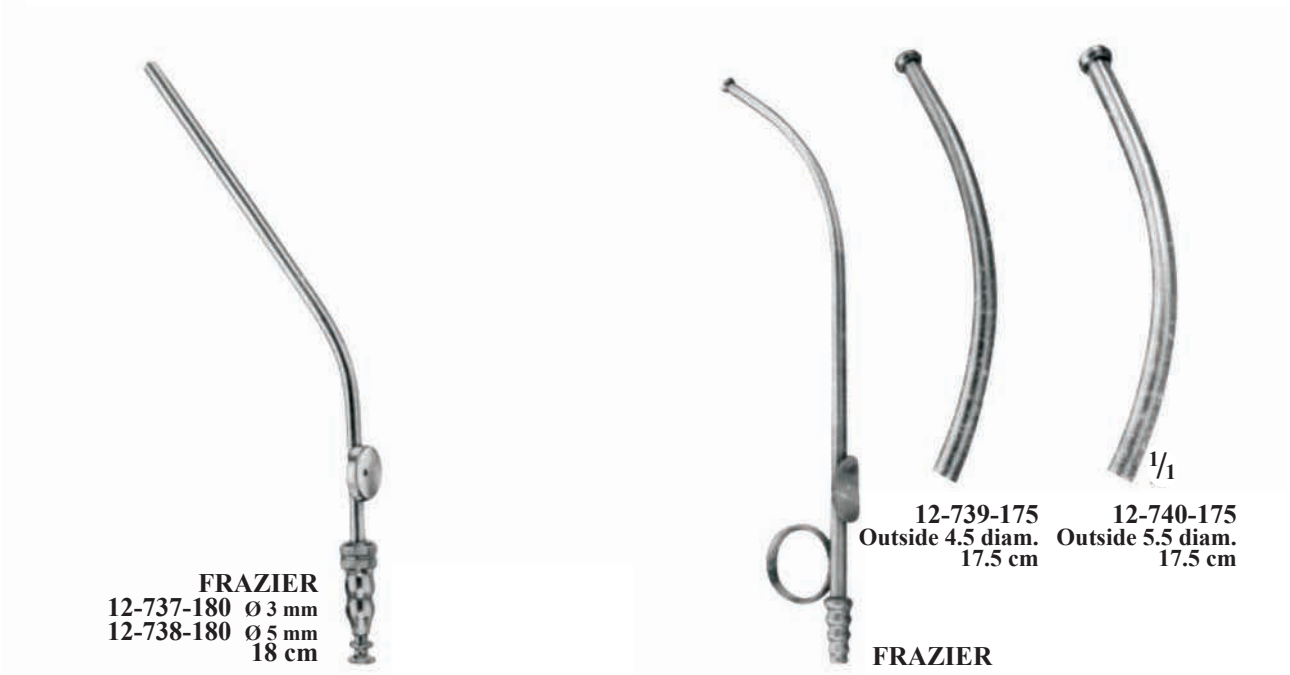

FRAZIER
 12-737-180 Ø 3 mm
 12-738-180 Ø 5 mm
 18 cm

12-739-175
 Outside 4.5 diam.
 17.5 cm

12-740-175
 Outside 5.5 diam.
 17.5 cm

FRAZIER

Tracheal – трахеотомия



TRACHEA TUBE
outer tube window
inner tube window
12-741-001

| Fig. | Item | Ø | L |
|------|------------|-------|-------|
| A | 12-742-060 | 7 mm | 60 mm |
| A | 12-743-065 | 8 mm | 65 mm |
| A | 12-744-070 | 9 mm | 70 mm |
| A | 12-745-075 | 10 mm | 75 mm |
| A | 12-746-080 | 11 mm | 80 mm |
| A | 12-747-085 | 12 mm | 85 mm |
| A | 12-748-090 | 13 mm | 90 mm |



SPEAKING TUBE
outer tube closed
inner tube closed
12-749-001

| Fig. | Item | Ø | L | Radius |
|------|------------|-------|-------|--------|
| A | 12-750-095 | 08 mm | 95 mm | 50 mm |
| A | 12-751-095 | 09 mm | 95 mm | 50 mm |
| A | 12-752-095 | 10 mm | 95 mm | 50 mm |
| A | 12-753-095 | 11 mm | 95 mm | 50 mm |
| A | 12-754-095 | 12 mm | 95 mm | 50 mm |
| A | 12-755-095 | 13 mm | 95 mm | 50 mm |

International scale for tracheal tubes, metal

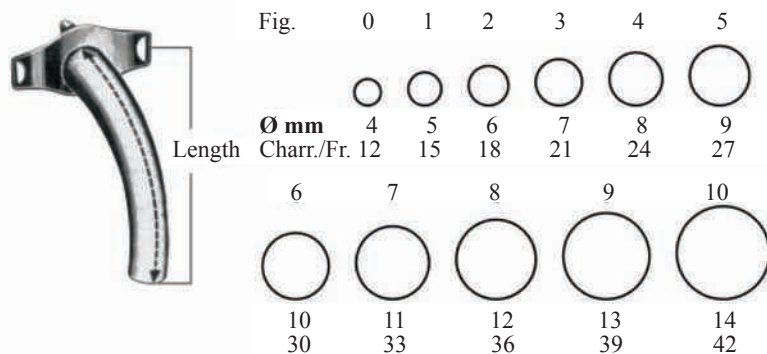

**LUER
GERMAN SILVER**
Diam. X.Length

| | | |
|-----------------|-----|------------|
| 12-756-095 Fig. | 0= | 4 x 50 mm |
| 12-757-095 Fig. | 1= | 5 x 50 mm |
| 12-758-095 Fig. | 2= | 6 x 50 mm |
| 12-759-095 Fig. | 3= | 7 x 55 mm |
| 12-760-095 Fig. | 4= | 8 x 60 mm |
| 12-761-095 Fig. | 5= | 9 x 65 mm |
| 12-762-095 Fig. | 6= | 10 x 70 mm |
| 12-763-095 Fig. | 7= | 11 x 80 mm |
| 12-764-095 Fig. | 8= | 12 x 90 mm |
| 12-765-095 Fig. | 9= | 13 x 90 mm |
| 12-766-095 Fig. | 10= | 14 x 90 mm |

JACKSON
short pattern with obturator
Diam. X.Length

| | | |
|-----------------|-----|------------|
| 12-767-095 Fig. | 1= | 5 x 36 mm |
| 12-768-095 Fig. | 2= | 6 x 44 mm |
| 12-769-095 Fig. | 3= | 7 x 48 mm |
| 12-770-095 Fig. | 4= | 8 x 52 mm |
| 12-771-095 Fig. | 5= | 9 x 56 mm |
| 12-772-095 Fig. | 6= | 10 x 56 mm |
| 12-773-095 Fig. | 7= | 11 x 56 mm |
| 12-774-095 Fig. | 8= | 12 x 56 mm |
| 12-775-095 Fig. | 9= | 13 x 56 mm |
| 12-776-095 Fig. | 10= | 14 x 56 mm |



Diam. X.Length

| | | |
|-----------------|----|------------|
| 12-777-095 Fig. | 5= | 9 x 65 mm |
| 12-778-095 Fig. | 6= | 10 x 70 mm |
| 12-779-095 Fig. | 7= | 11 x 80 mm |

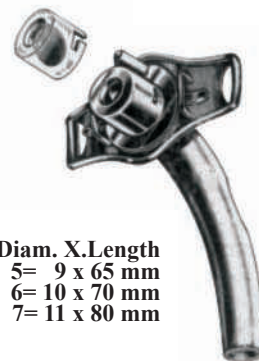

Speaking Tube

**Tracheal –
трахеотомия**



LABORDE
12-780-140
14 cm

TROUSSEAU
12-781-140
14 cm



COLLIN
12-782-160 16 cm
12-783-180 18 cm

YOUNG
12-784-170
17 cm

*Tracheal set –
набор для трахеотомии*

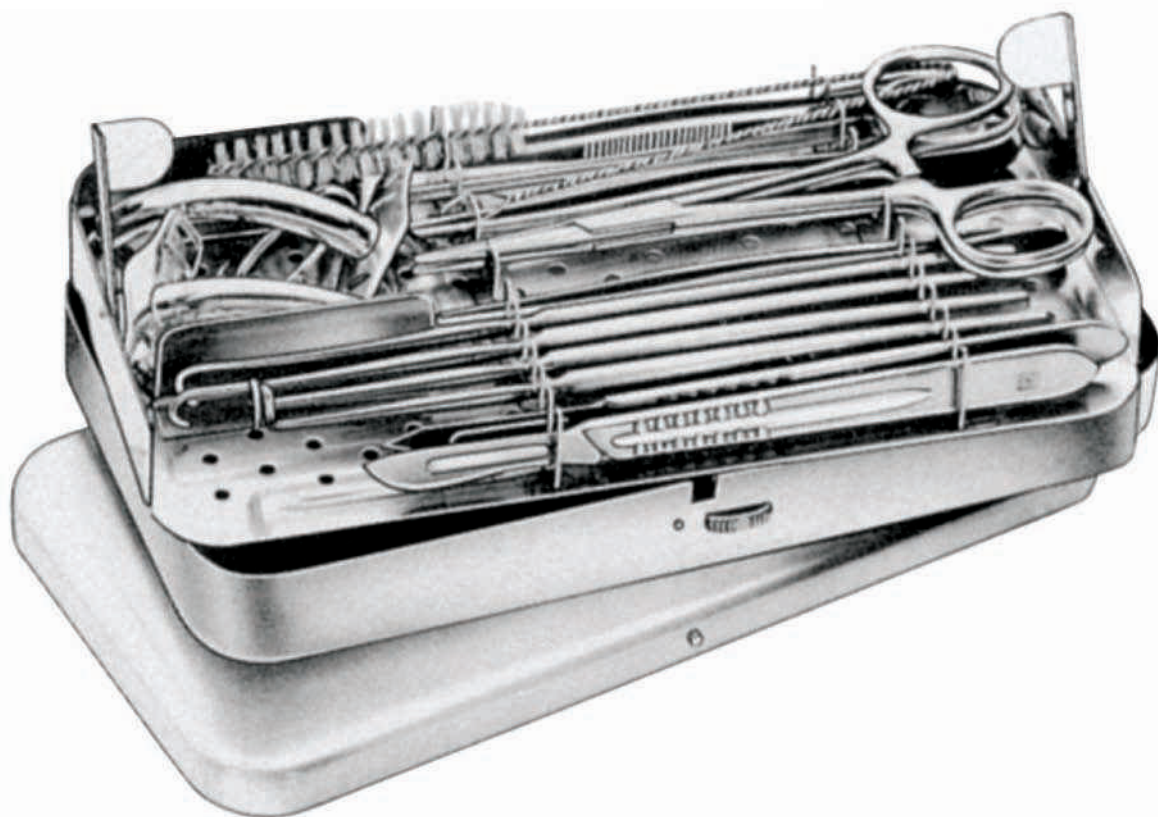

- 12-787-002 1 Metal Case
- 12-788-003 1 Handle With 1 Blade Fig.20
- 12-789-004 1 Handle With 1 Blade Fig.23
- 12-790-005 1 Dressing Forceps 13 cm
- 12-791-006 2 Tissue Artery Forceps 13 cm
- 12-792-007 2 Pean Artery Forceps 13 cm
- 12-793-008 1 Grooved Director 13 cm
- 12-794-009 1 Trachea Dilator Bose
- 12-795-0010 2 Trachea Retractors, Iterson, Blunt
- 12-796-0012 1 Trachea Retractor, Bosse, Sharp, Left
- 12-797-0013 1 Trachea Retractor, Bosse, Sharp, Right
- 12-798-0014 1 Luer Trachea Tube Standard, Fig. 3
- 12-799-0015 1 Luer Trachea Tube Standard, Fig. 4
- 12-800-0016 1 Cleaning Brush

**Tracheal –
крючки для трахеотомии**

