

# SECTION – 10

## Cardiovascular & thoracic instruments *кардиоваскулярный и торакальный инструмент*



**Thoracic / cardiovascular – инструменты  
для торакально-кардиоваскулярной хирургии**



10-001-080  
Length 8 cm  
Jaw 2 cm  
Straight

10-002-090  
Length 9 cm  
Jaw 3 cm  
Straight

10-003-105  
Length 10.5 cm  
Jaw 4.5 cm  
Straight

10-004-125  
Length 12.5 cm  
Jaw 6.8 cm  
Straight

**DEBAKEY**



10-005-075  
Length 7.5 cm  
Jaw 2 cm  
Curved

10-006-085  
Length 8.5 cm  
Jaw 3 cm  
Curved

10-007-095  
Length 9.5 cm  
Jaw 4.5 cm  
Curved

10-008-115  
Length 11.5 cm  
Jaw 6.8 cm  
Curved

**DEBAKEY**

**Thoracic / cardiovascular – инструменты  
для торакально-кардиоваскулярной хирургии**

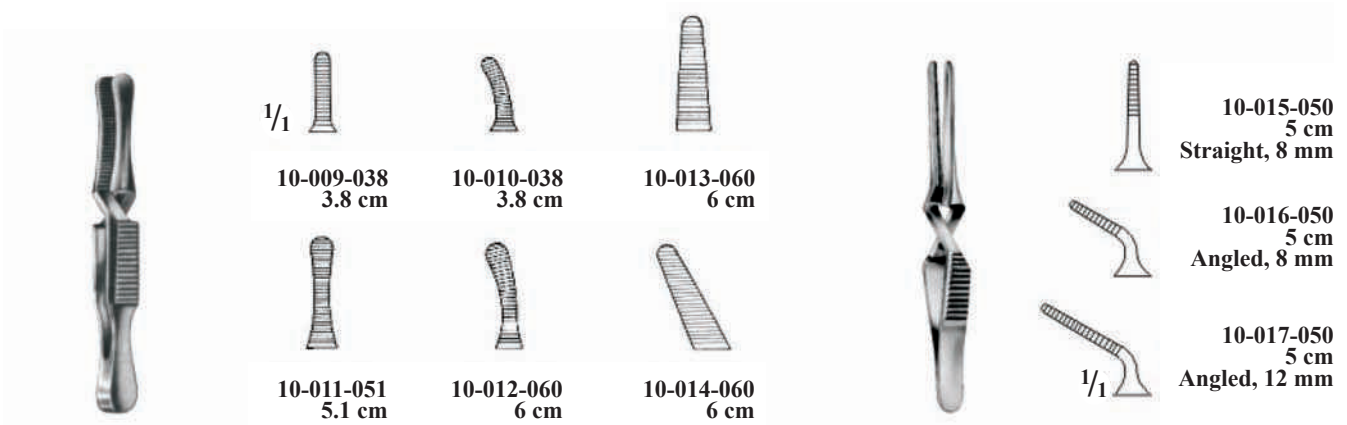

**BULLDOG CLAMP**

**DIETHRICH / MICRO  
CORONARY**

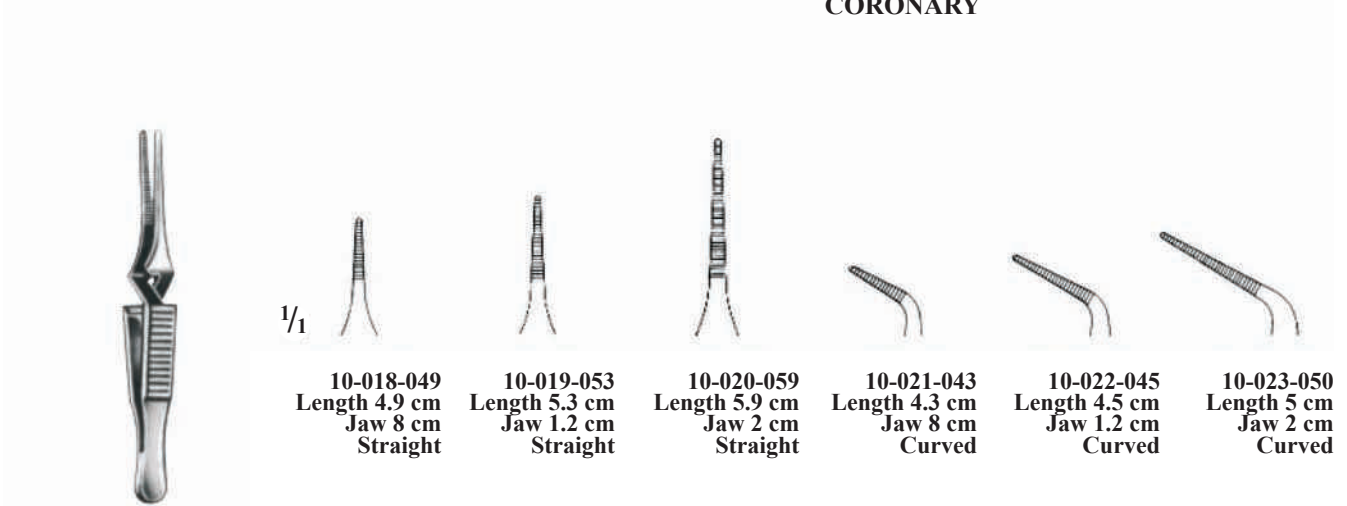

**BULLDOG CLAMP**



10-024-040  
Titan 4 cm

10-025-040  
Titan 4 cm

10-026-040  
Titan 4 cm

**Thoracic / cardiovascular – инструменты  
для торакально-кардиоваскулярной хирургии**

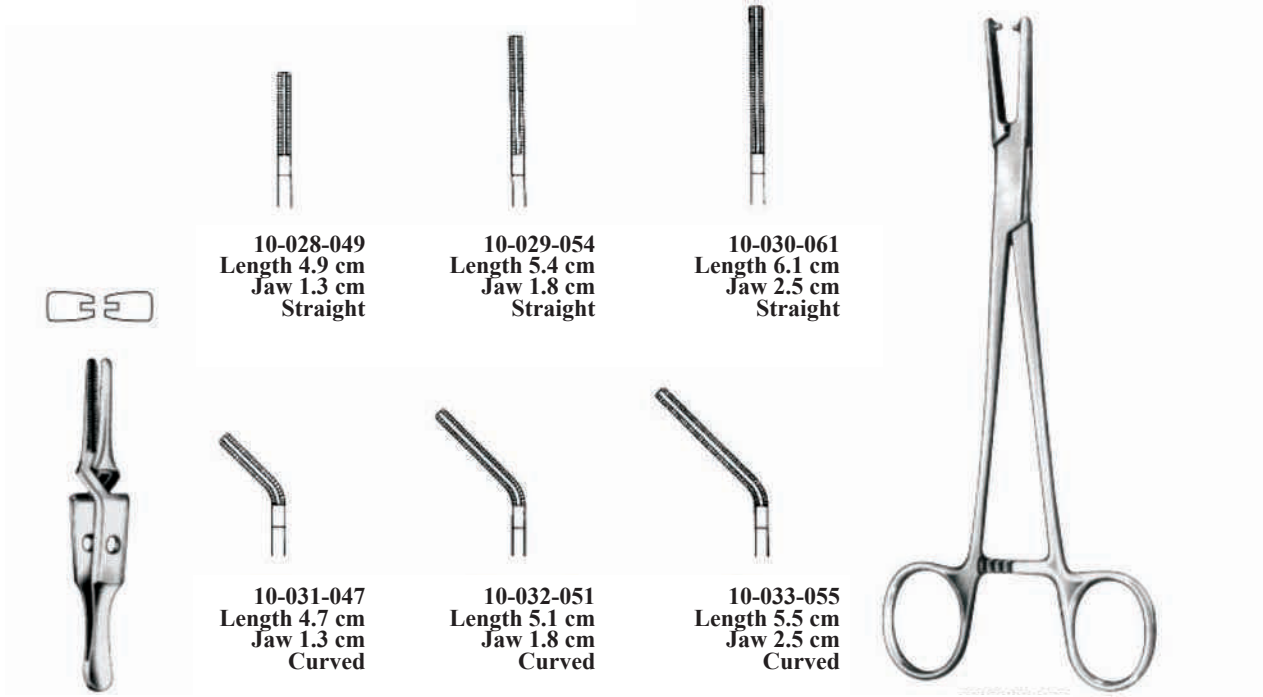

10-028-049  
Length 4.9 cm  
Jaw 1.3 cm  
Straight

10-029-054  
Length 5.4 cm  
Jaw 1.8 cm  
Straight

10-030-061  
Length 6.1 cm  
Jaw 2.5 cm  
Straight

10-031-047  
Length 4.7 cm  
Jaw 1.3 cm  
Curved

10-032-051  
Length 5.1 cm  
Jaw 1.8 cm  
Curved

10-033-055  
Length 5.5 cm  
Jaw 2.5 cm  
Curved

**WICKHAM**  
10-034-240  
24 cm

**WICKHAM MINI**

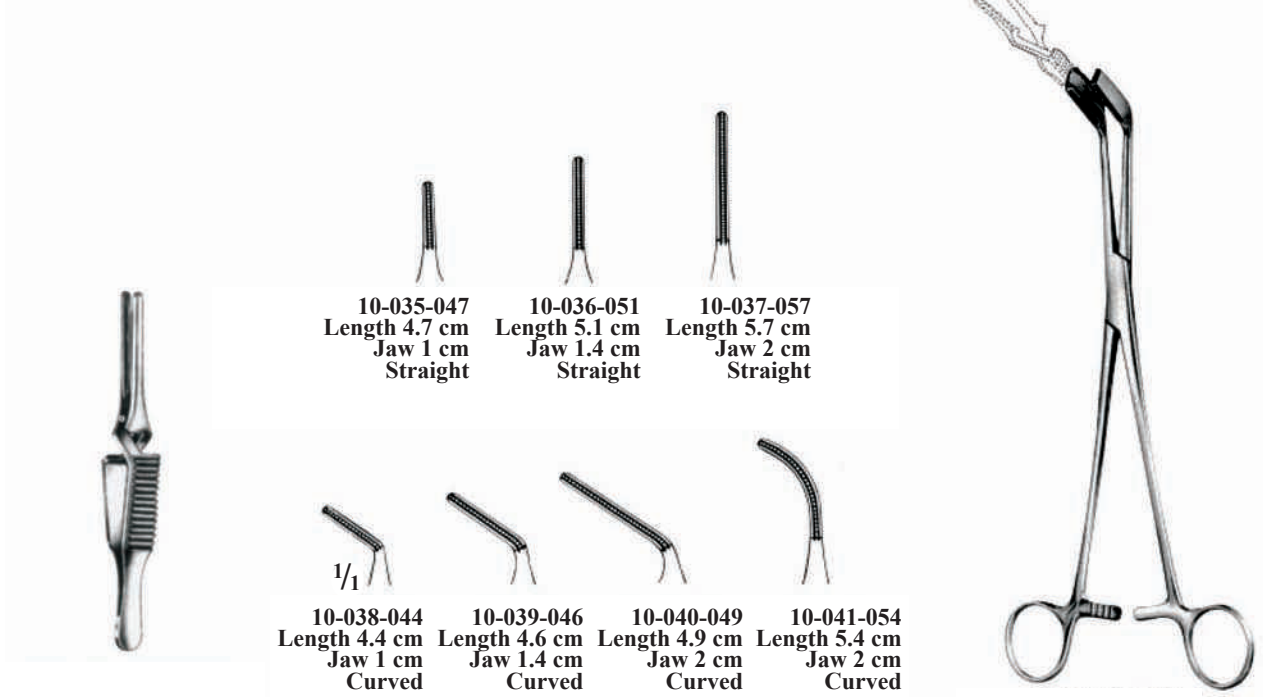

10-035-047  
Length 4.7 cm  
Jaw 1 cm  
Straight

10-036-051  
Length 5.1 cm  
Jaw 1.4 cm  
Straight

10-037-057  
Length 5.7 cm  
Jaw 2 cm  
Straight

10-038-044  
Length 4.4 cm  
Jaw 1 cm  
Curved

10-039-046  
Length 4.6 cm  
Jaw 1.4 cm  
Curved

10-040-049  
Length 4.9 cm  
Jaw 2 cm  
Curved

10-041-054  
Length 5.4 cm  
Jaw 2 cm  
Curved

**JOHN-HOPKINS**  
10-042-245  
24.5 cm

**DEBAKEY-DIETRICH**

**Thoracic / cardiovascular – инструменты для торакально-кардиоваскулярной хирургии**

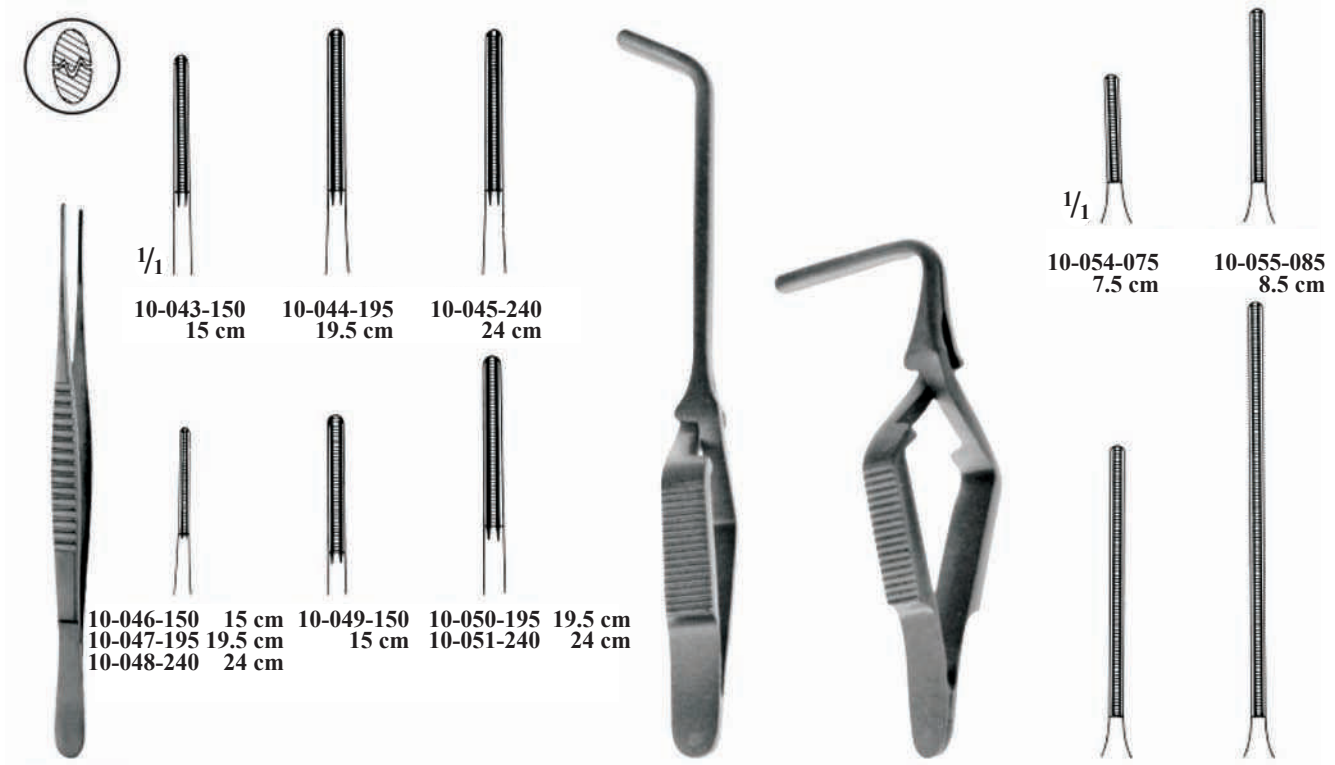

1/1  
 10-043-150 15 cm  
 10-044-195 19.5 cm  
 10-045-240 24 cm

10-046-150 15 cm  
 10-047-195 19.5 cm  
 10-048-240 24 cm  
 10-049-150 15 cm  
 10-050-195 19.5 cm  
 10-051-240 24 cm

1/1  
 10-054-075 7.5 cm  
 10-055-085 8.5 cm

**DE BAKEY**

10-052-110 11 cm  
 10-053-001  
 10-055-105 10.5 cm  
 10-056-120 12 cm

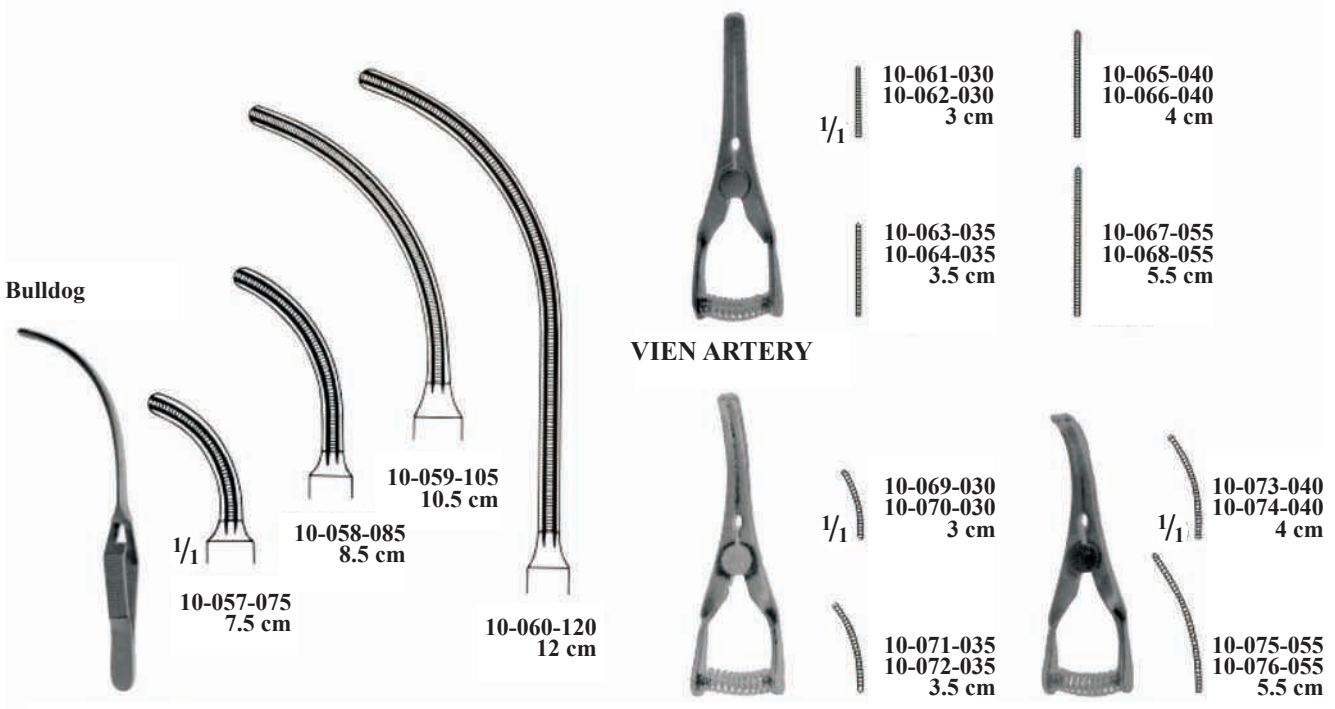

**Bulldog**

1/1  
 10-057-075 7.5 cm  
 10-058-085 8.5 cm  
 10-059-105 10.5 cm  
 10-060-120 12 cm

1/1  
 10-061-030  
 10-062-030 3 cm  
 10-063-035  
 10-064-035 3.5 cm  
 10-065-040  
 10-066-040 4 cm  
 10-067-055  
 10-068-055 5.5 cm

**VIEN ARTERY**

1/1  
 10-069-030  
 10-070-030 3 cm  
 10-071-035  
 10-072-035 3.5 cm  
 10-073-040  
 10-074-040 4 cm  
 10-075-055  
 10-076-055 5.5 cm

**DE BAKEY**

**VIEN ARTERY**

**VIEN ARTERY**

**Thoracic / cardiovascular – инструменты  
для торакально-кардиоваскулярной хирургии**

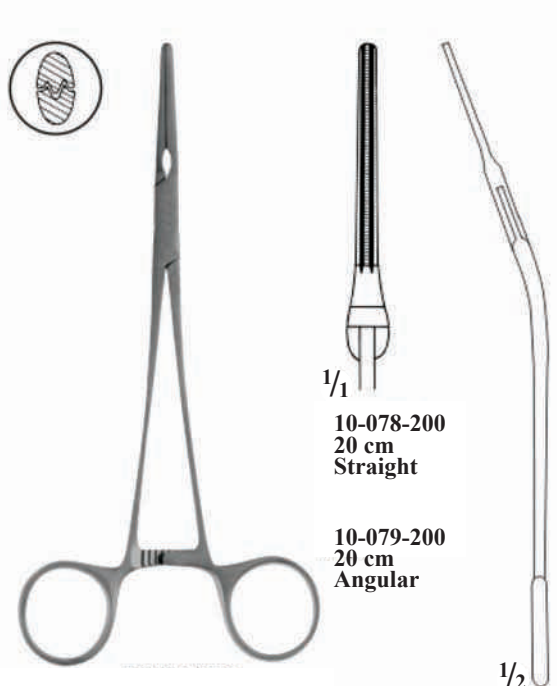

**DE BAKEY**

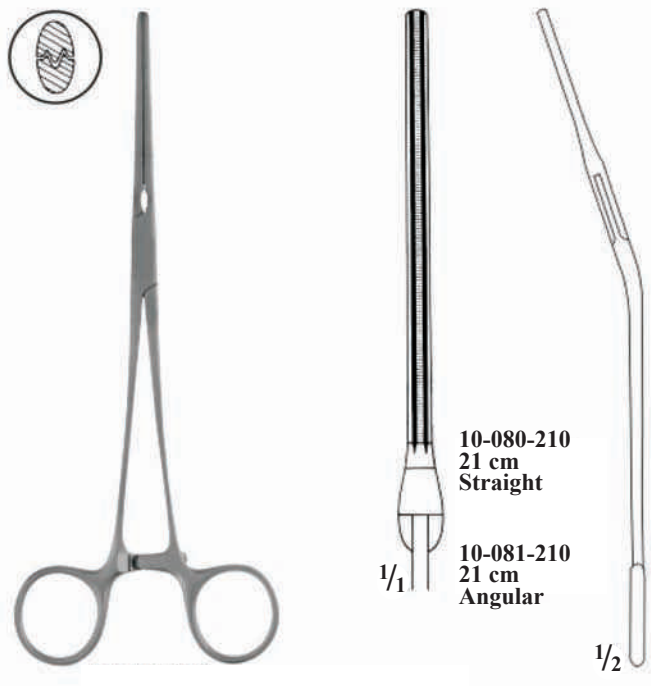

**DE BAKEY**

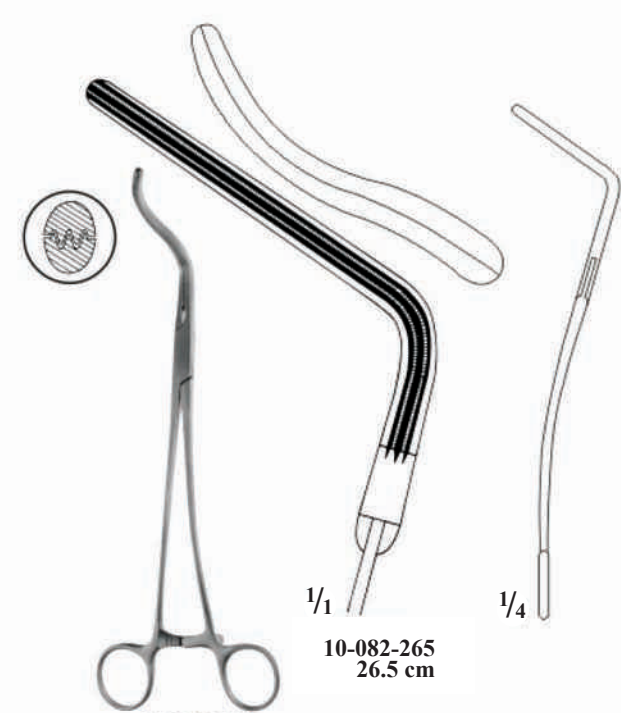

**DE BAKEY**



**DE BAKEY**

**Thoracic / cardiovascular – инструменты  
для торакально-кардиоваскулярной хирургии**



**DE BAKHEY**



**DE BAKHEY**



**DE BAKHEY**

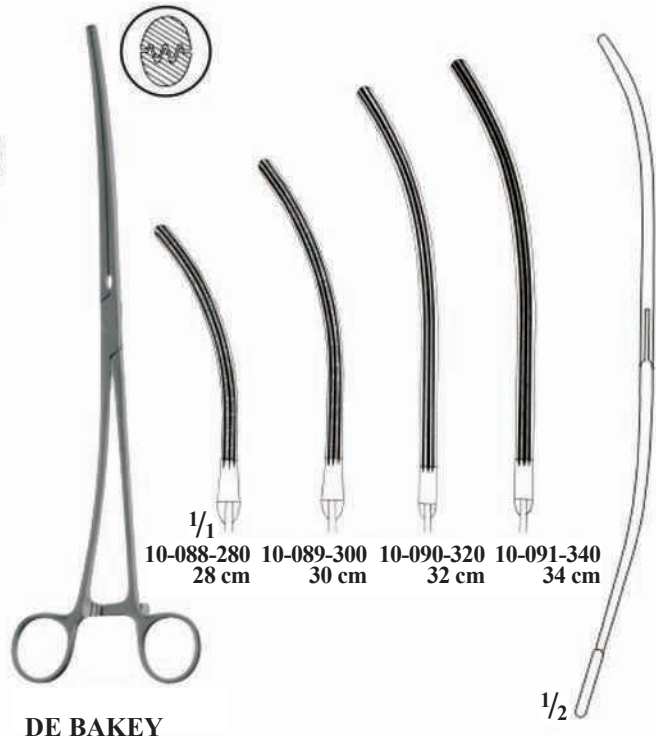

**DE BAKHEY**

**Thoracic / cardiovascular – инструменты  
для торакально-кардиоваскулярной хирургии**

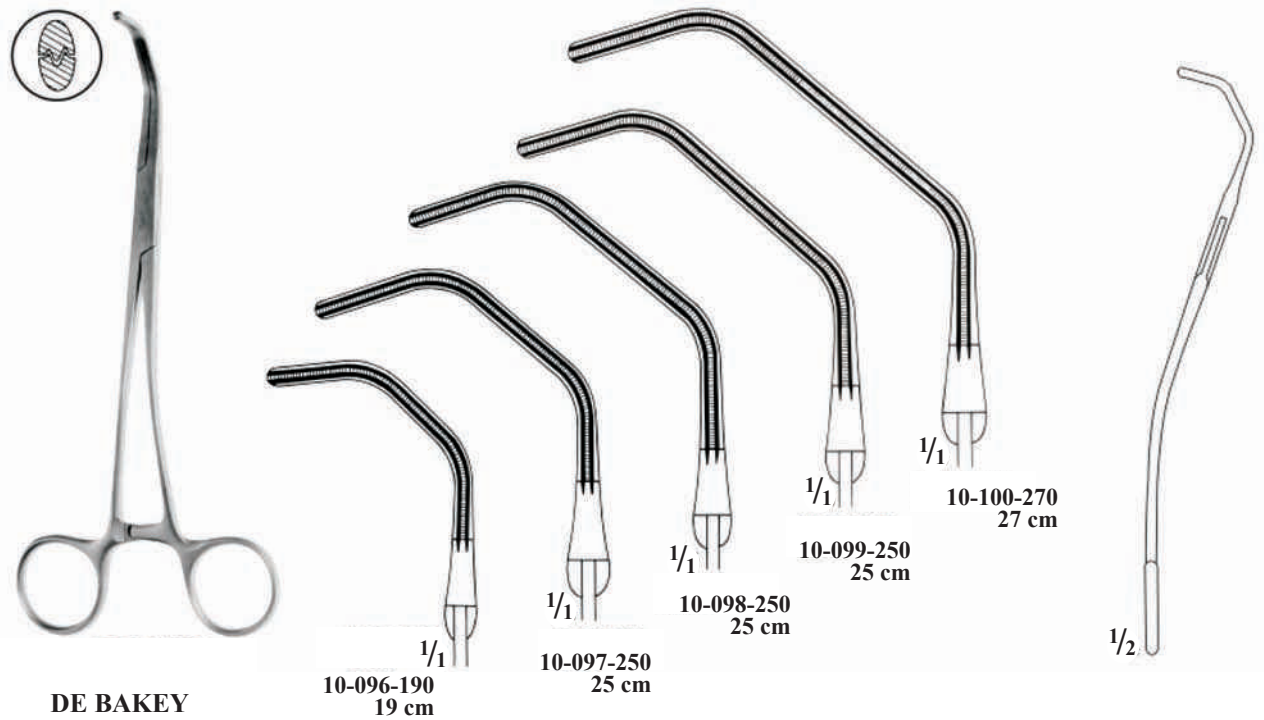
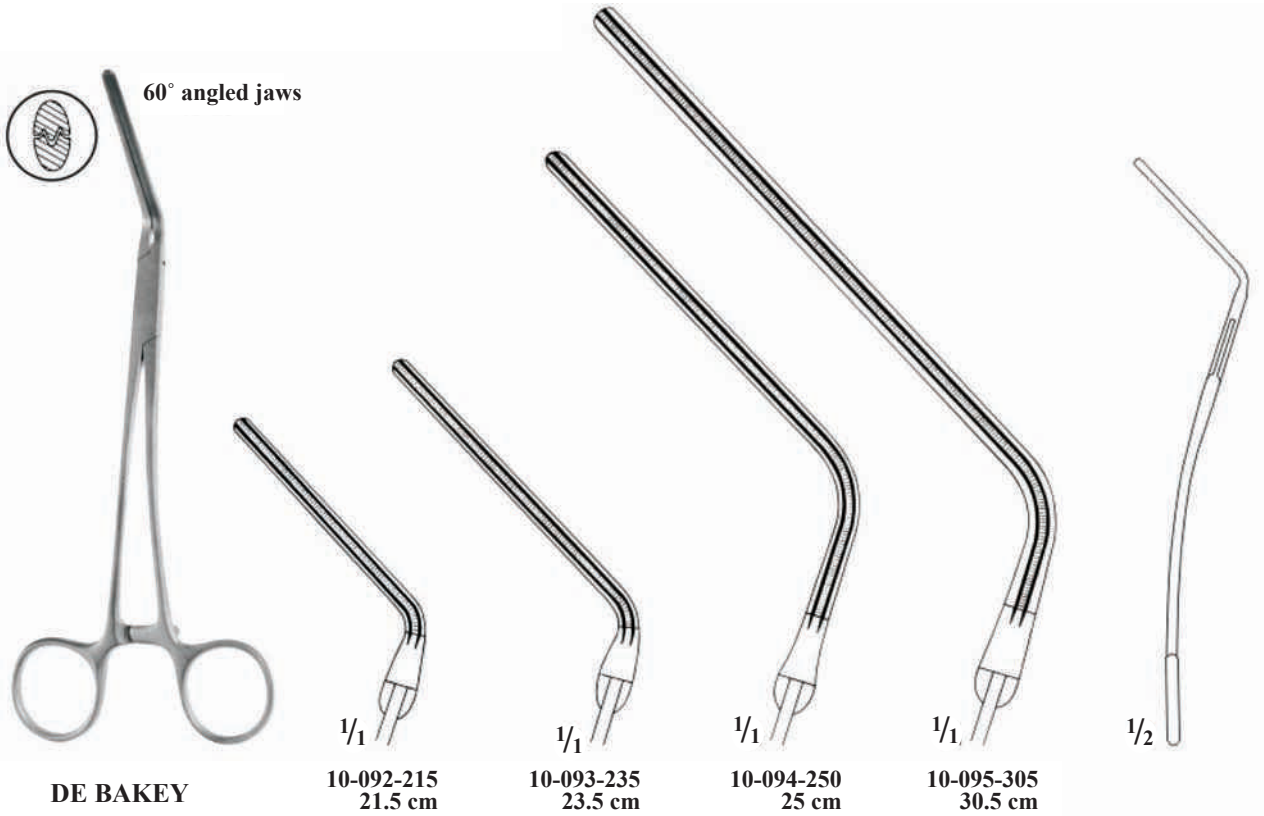



**Thoracic / cardiovascular – инструменты  
для торакально-кардиоваскулярной хирургии**

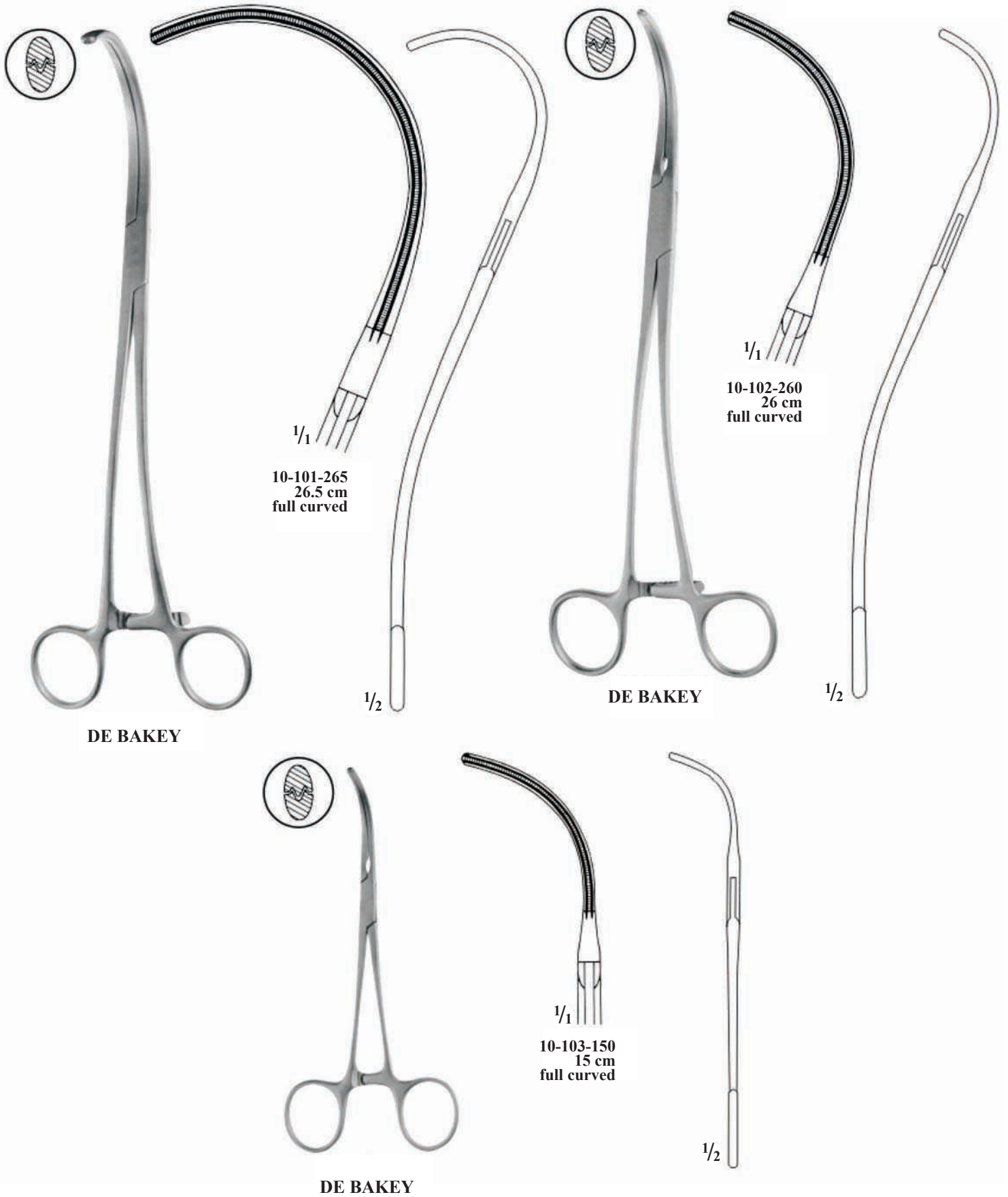

**Thoracic / cardiovascular – инструменты  
для торакально-кардиоваскулярной хирургии**



**DE BAKEY**

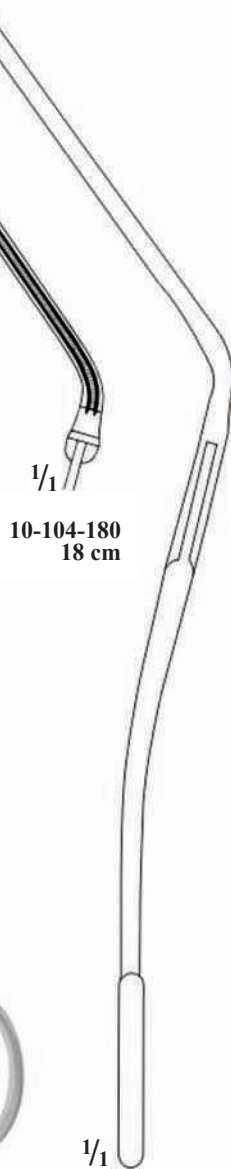

10-104-180  
18 cm

1/1

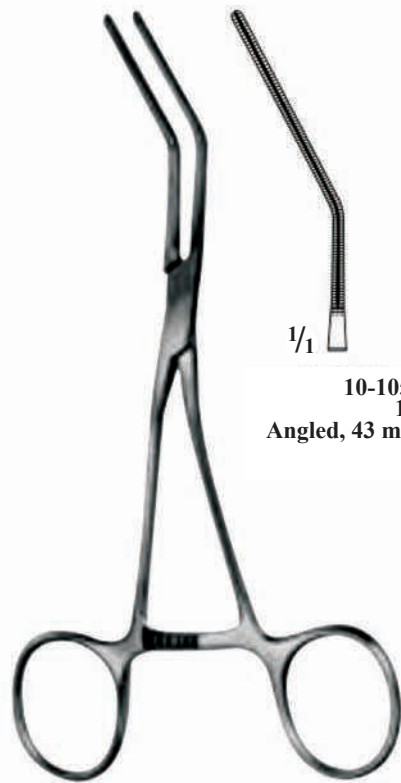

**DE BAKEY / PEDIATRIC**

10-105-120  
12 cm  
Angled, 43 mm tip

1/1

**Thoracic / cardiovascular – инструменты  
для торакально-кардиоваскулярной хирургии**

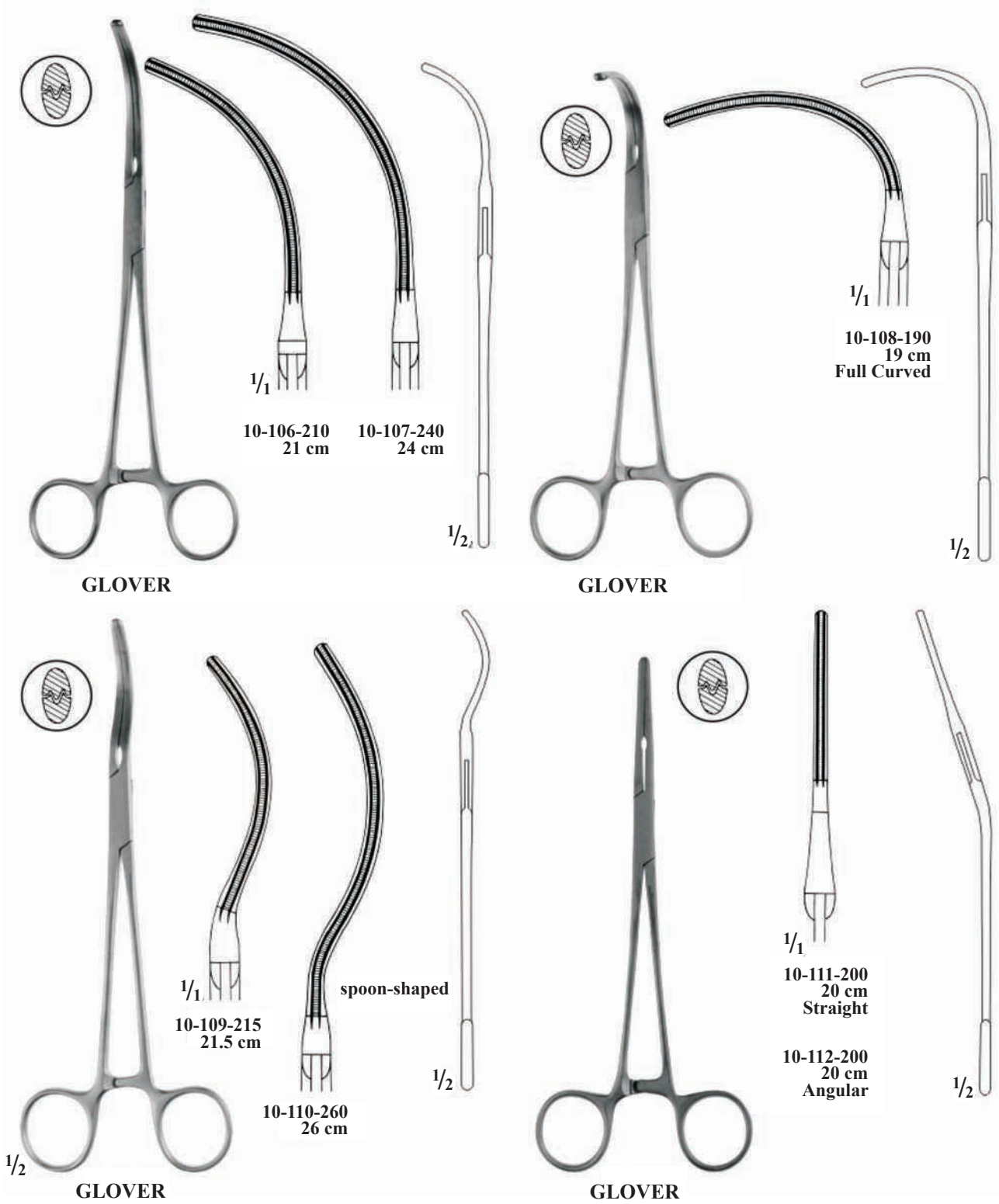

**Thoracic / cardiovascular – инструменты  
для торакально-кардиоваскулярной хирургии**

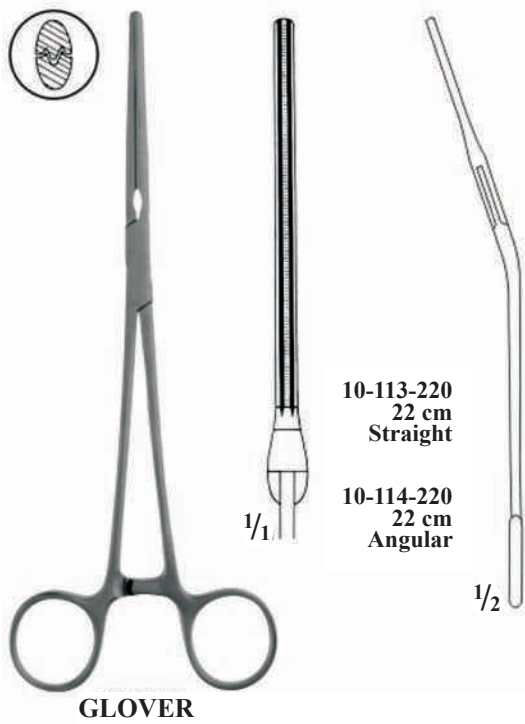

10-113-220  
22 cm  
Straight

10-114-220  
22 cm  
Angular

**GLOVER**



10-115-250  
25 cm

**GLOVER**

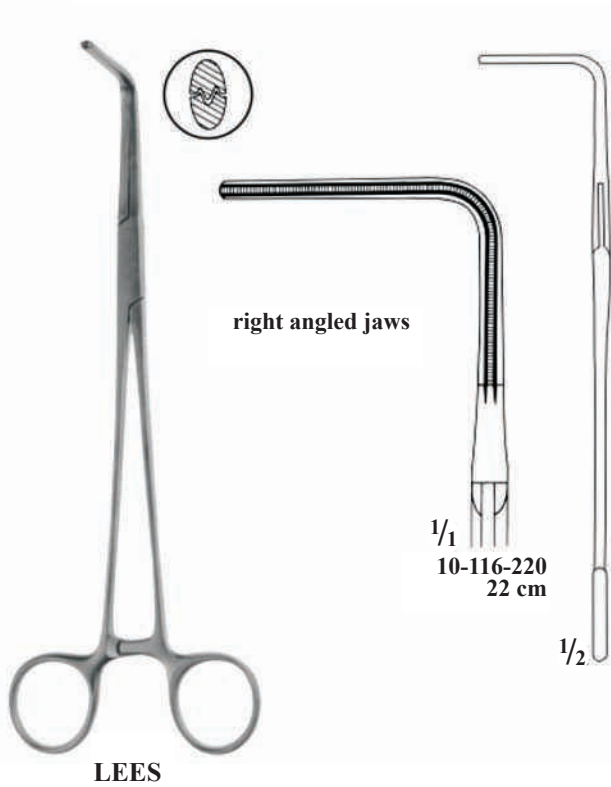

right angled jaws

10-116-220  
22 cm

**LEES**

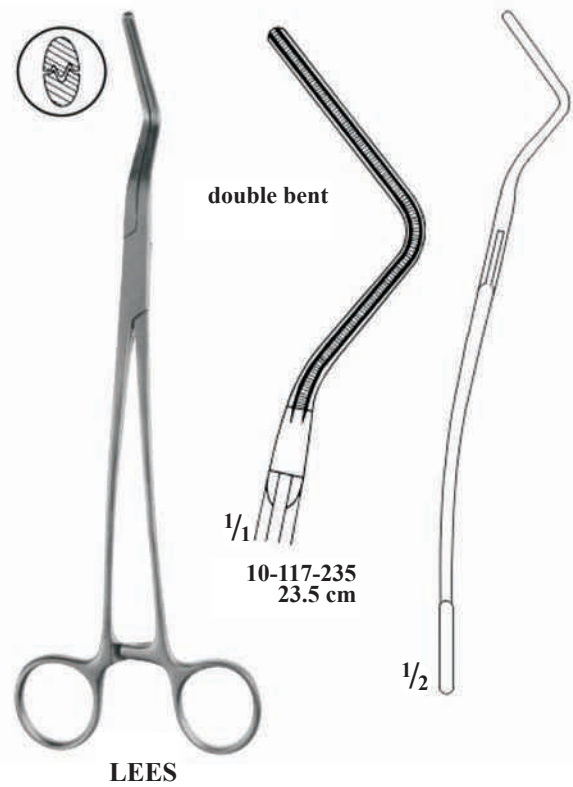

double bent

10-117-235  
23.5 cm

**LEES**

**Thoracic / cardiovascular – инструменты  
для торакально-кардиоваскулярной хирургии**

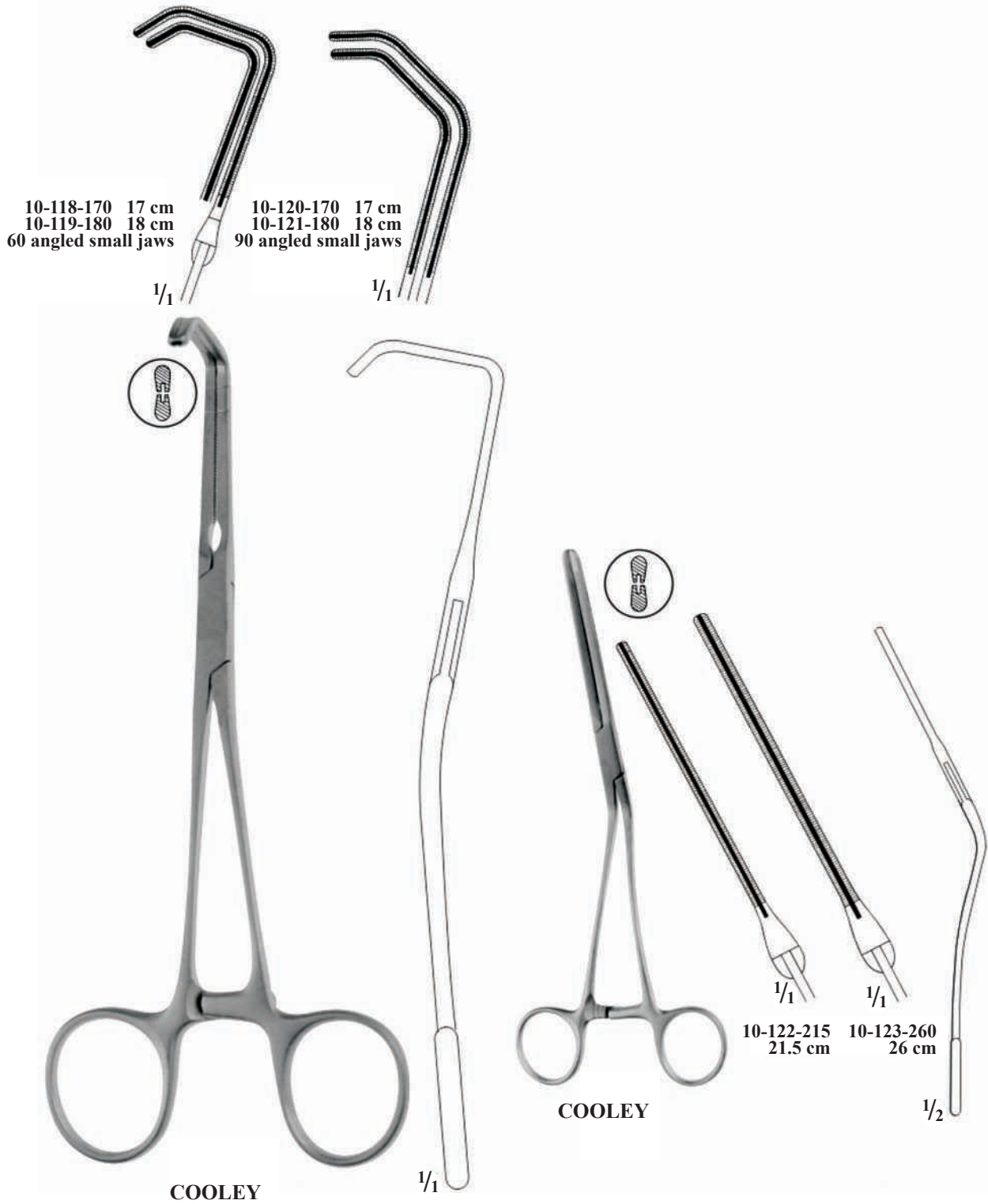

**Thoracic / cardiovascular – инструменты  
для торакально-кардиоваскулярной хирургии**

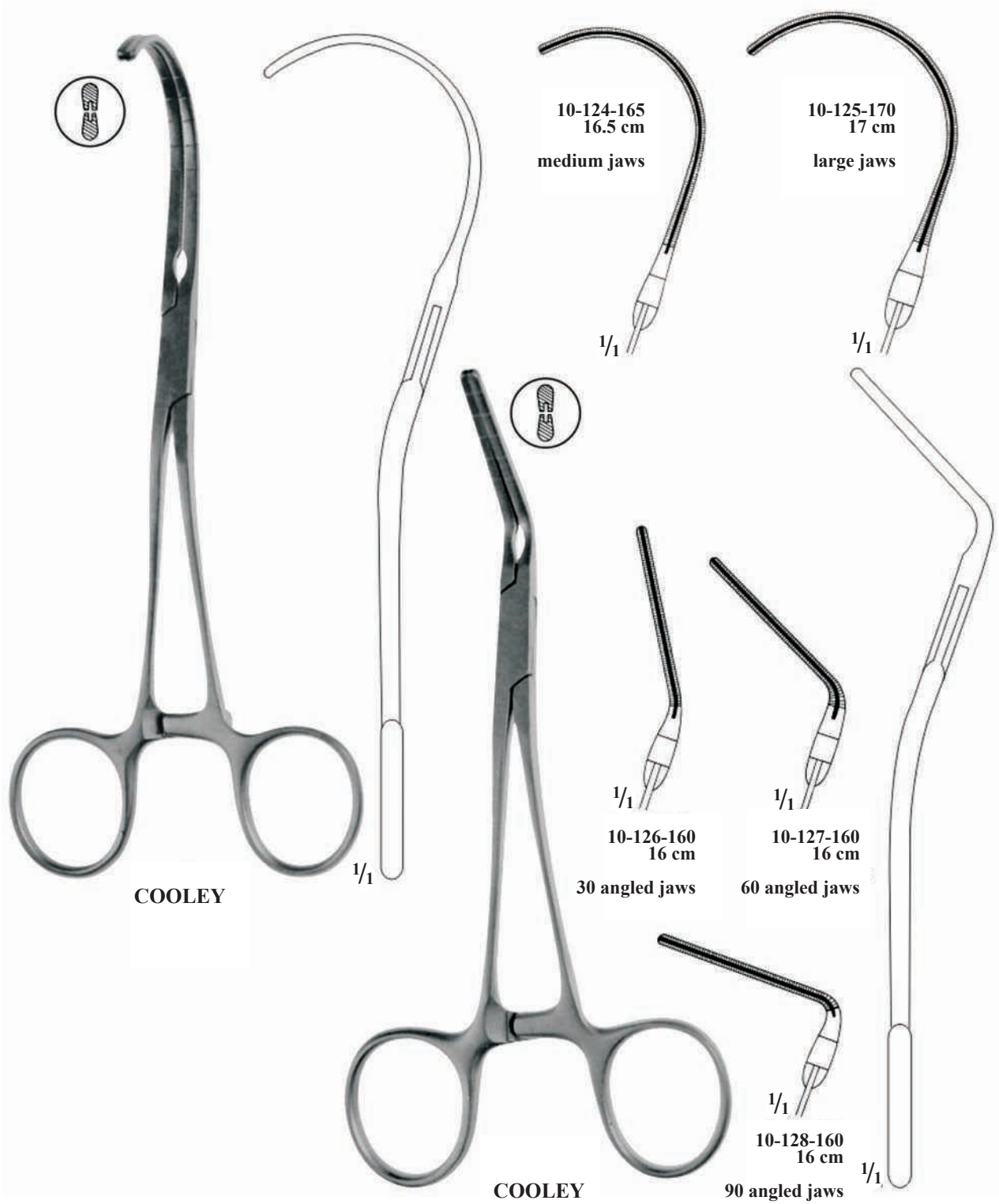

**Thoracic / cardiovascular – инструменты  
для торакально-кардиоваскулярной хирургии**

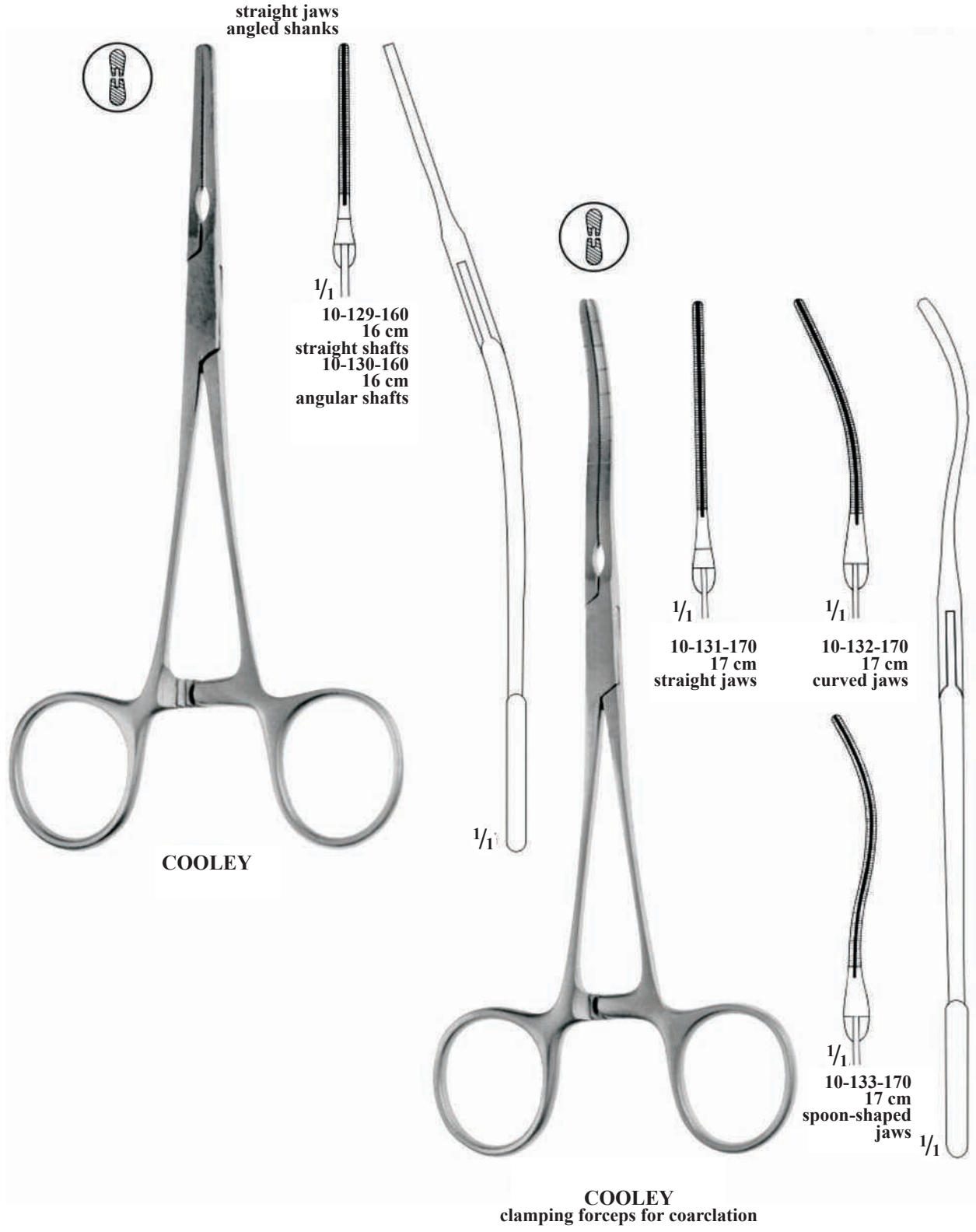

**Thoracic / cardiovascular – инструменты  
для торакально-кардиоваскулярной хирургии**

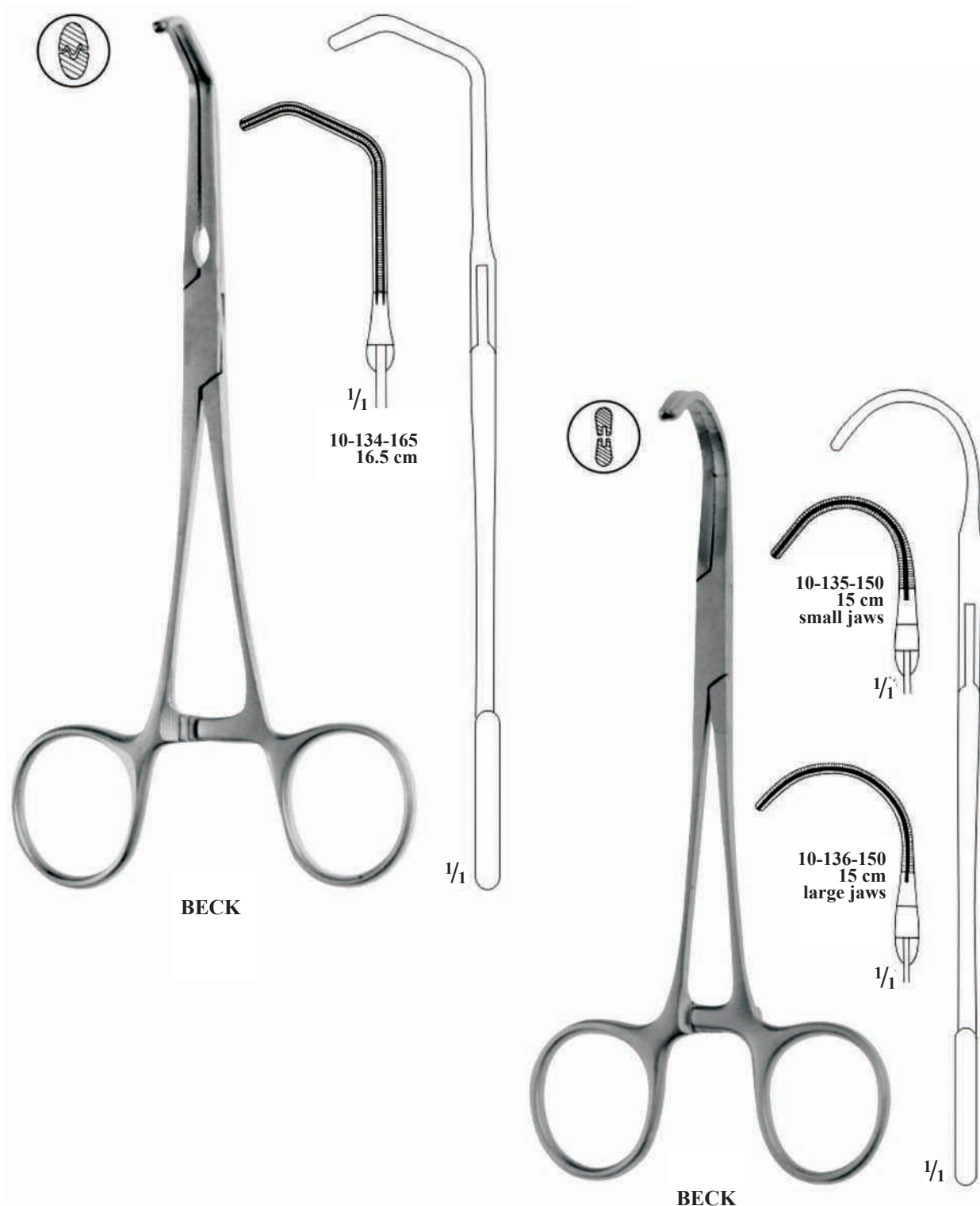



**Thoracic / cardiovascular – инструменты  
для торакально-кардиоваскулярной хирургии**

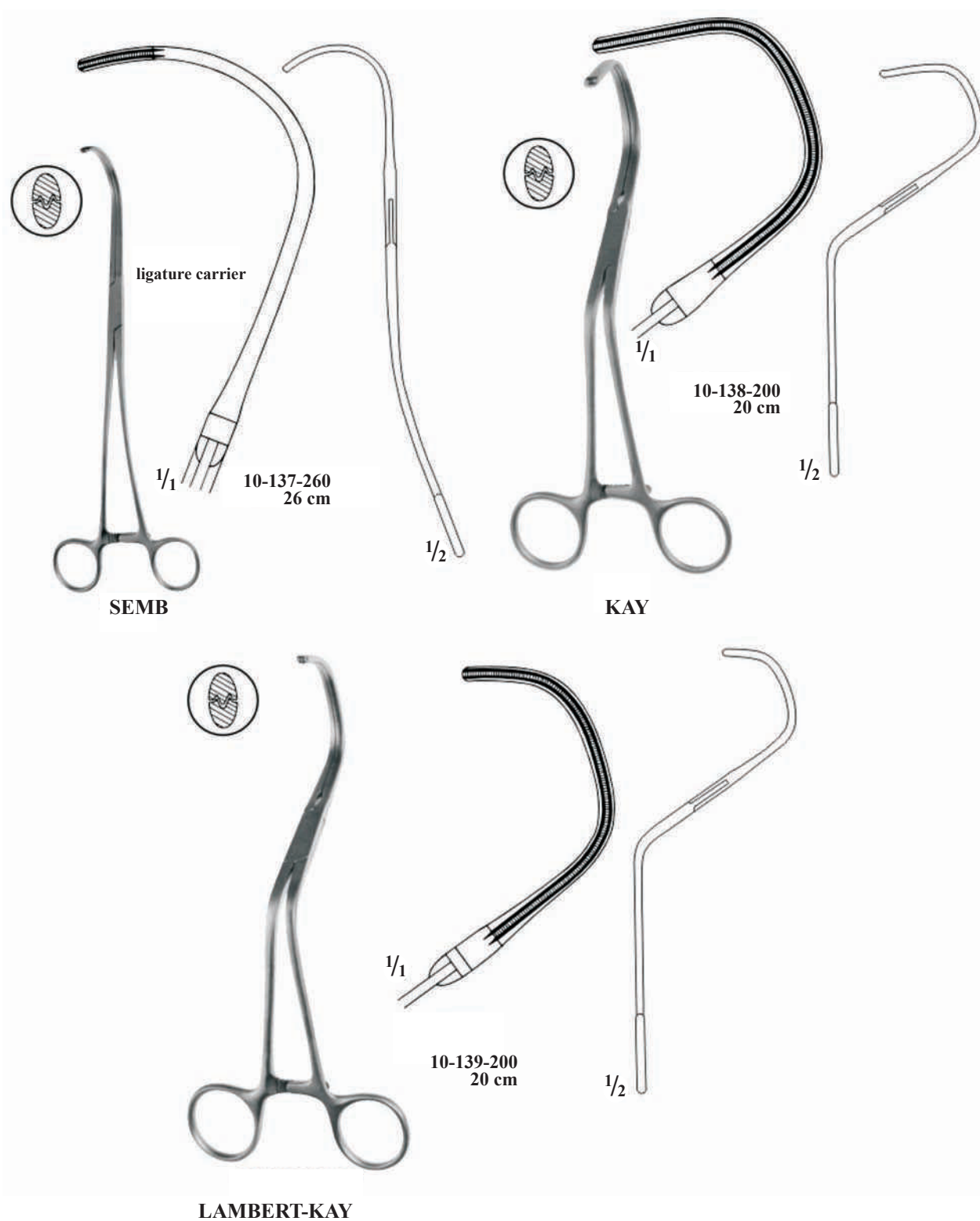

**Thoracic / cardiovascular – инструменты  
для торакально-кардиоваскулярной хирургии**

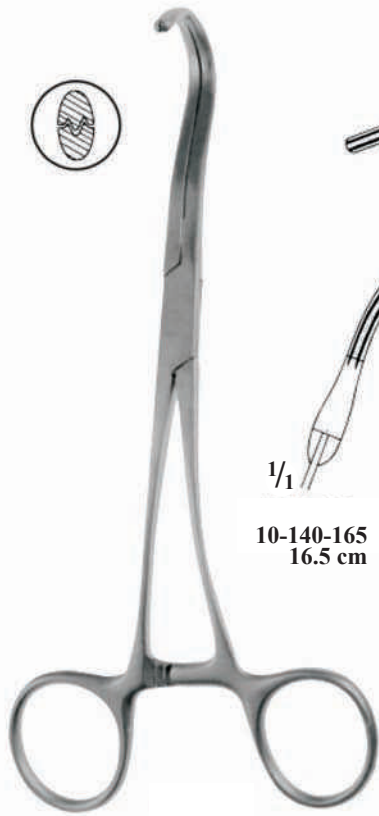

**DERRA**

$\frac{1}{1}$   
10-140-165  
16.5 cm

$\frac{1}{1}$   
10-141-179  
17 cm

$\frac{1}{1}$   
10-142-180  
18 cm



**RENAL**

double bent jaws  
curved shanks

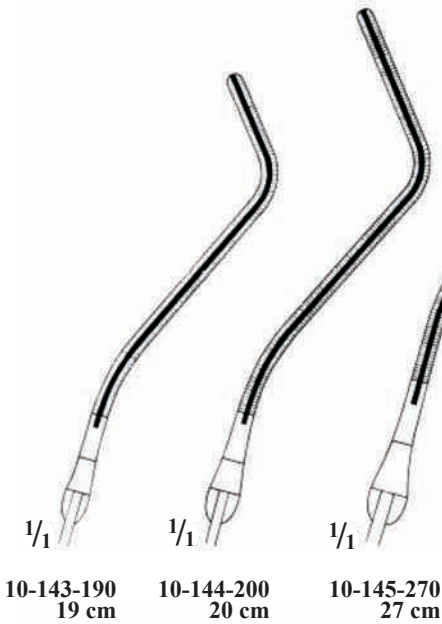

$\frac{1}{1}$   
10-143-190  
19 cm

$\frac{1}{1}$   
10-144-200  
20 cm

$\frac{1}{1}$   
10-145-270  
27 cm

**Thoracic / cardiovascular – инструменты  
для торакально-кардиоваскулярной хирургии**



**Thoracic / cardiovascular – инструменты  
для торакально-кардиоваскулярной хирургии**

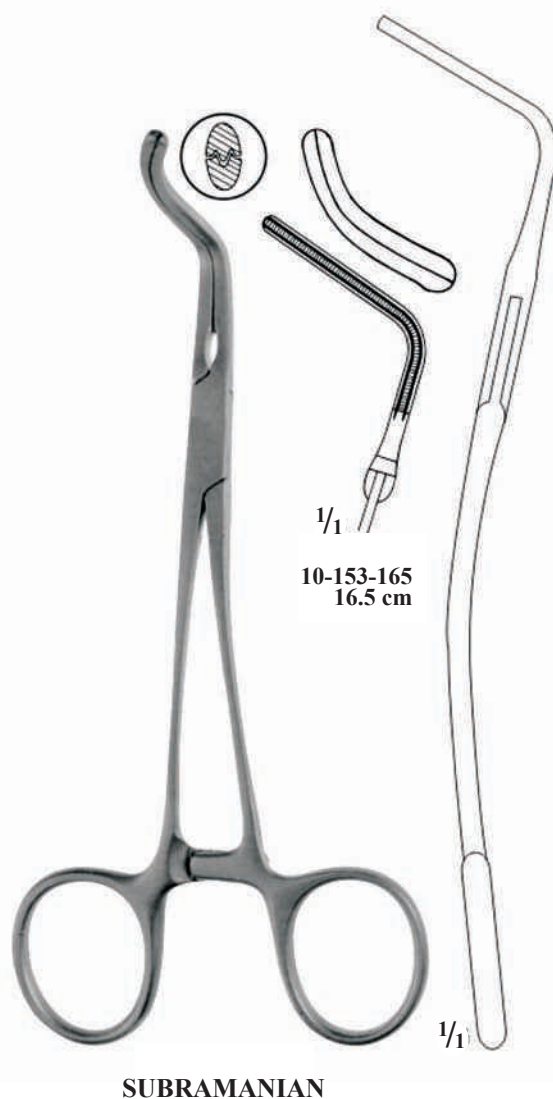
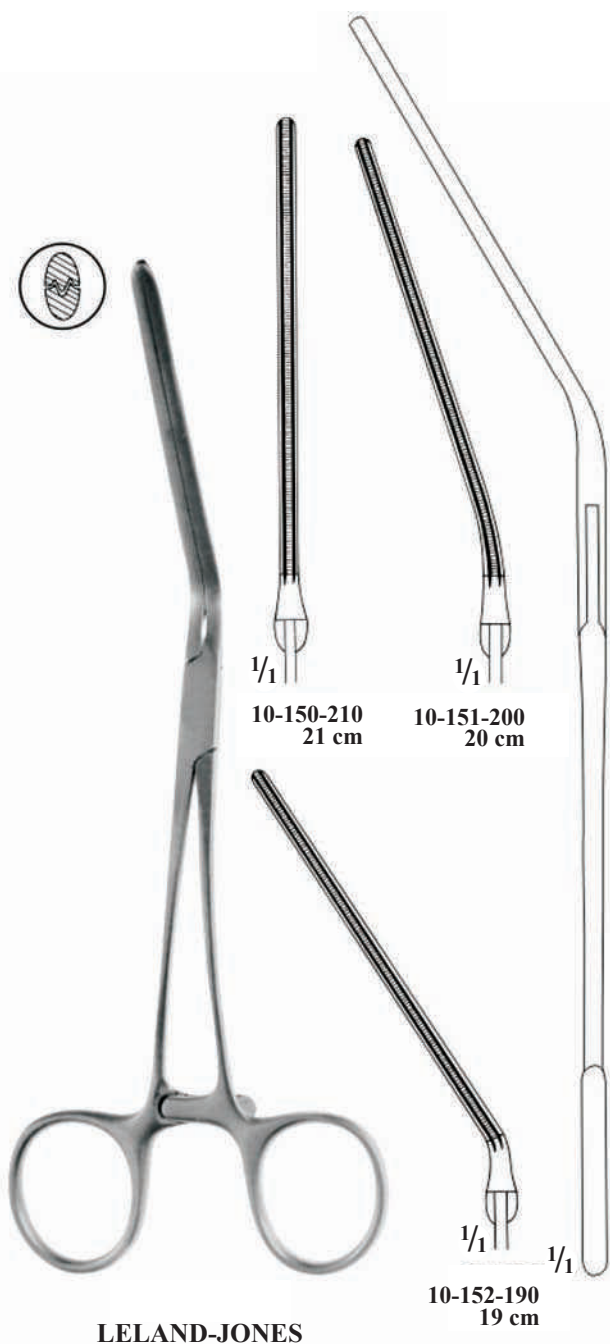

**Thoracic / cardiovascular – инструменты  
для торакально-кардиоваскулярной хирургии**

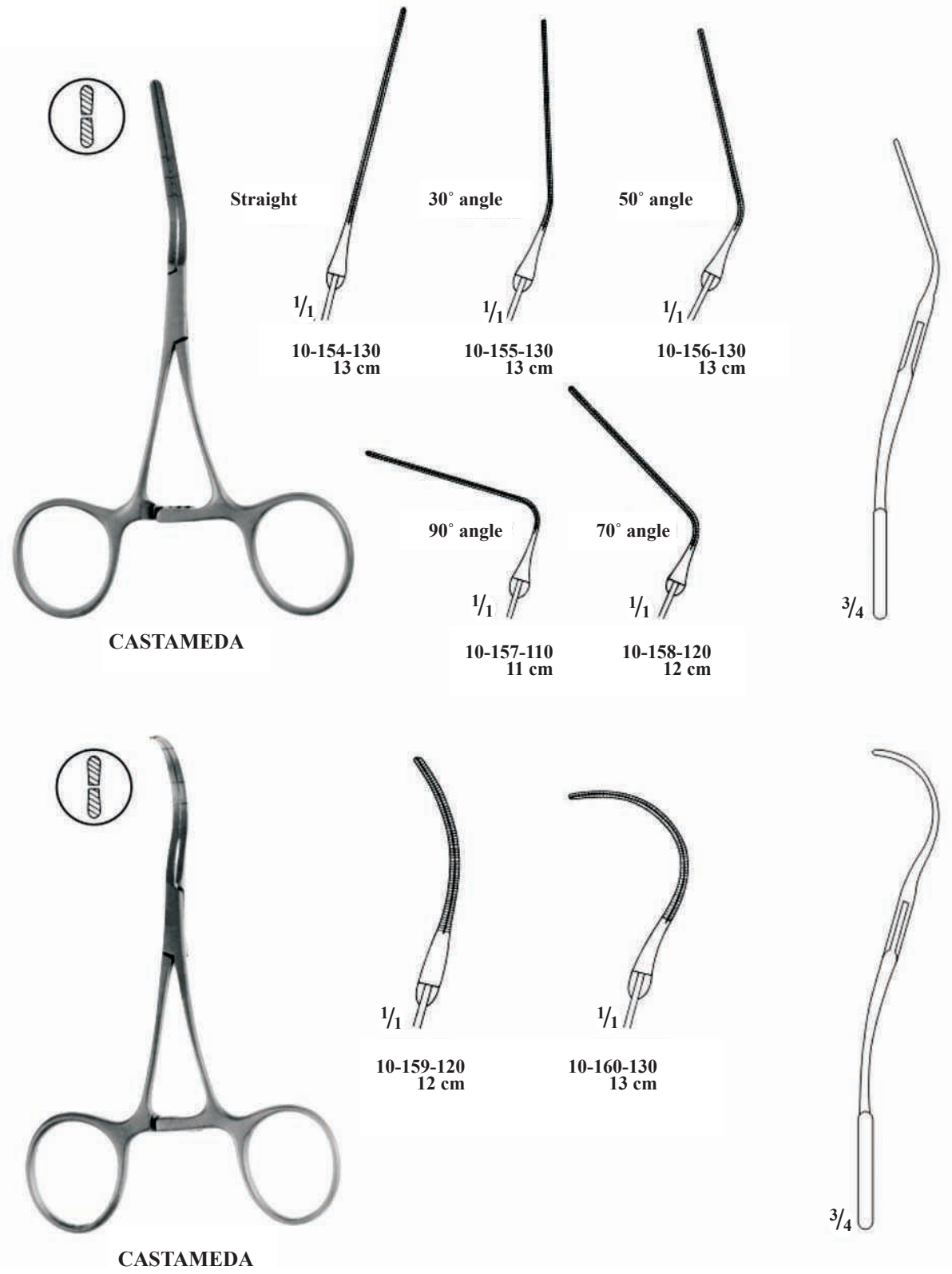

*Thoracic / cardiovascular – инструменты  
для торакально-кардиоваскулярной хирургии*



**PRICE-THOMAS**  
22 cm

1/1  
10-161-220  
22 cm



**PRICE THOMAS**  
22 cm

1/1  
10-162-220  
jaw with pins



10-163-220  
jaw with pins



**BABY-SATINSKY**

1/1  
10-164-150  
15 cm

**Thoracic / cardiovascular – инструменты  
для торакально-кардиоваскулярной хирургии**



**BAILEY-GIBBON**  
10-165-200  
20 cm  
For Adult



1/1

10-166-200  
20 cm  
For children



**BAILEY SELLORS RIB CONTRACTOR**  
10-167-150  
15 cm



10-168-200  
20 cm



**BLALOCK**

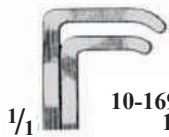

1/1

10-169-150  
15 cm



10-170-200  
20 cm

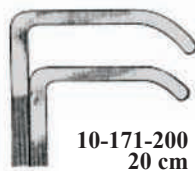

10-171-200  
20 cm



**JOHNS-HOPKINS  
(POYYS Modif.)**



1/1

10-172-200  
20 cm



10-173-200  
20 cm



10-174-200  
20 cm

*Thoracic / cardiovascular – инструменты  
для торакально-кардиоваскулярной хирургии*



**ALLISON**  
10-175-250  
25 cm



**ALLISON**  
10-176-320  
32 cm



**10-177-300**  
30 cm



**TUBBS**  
10-178-00  
Blade Opening  
From 8 To 42 cm

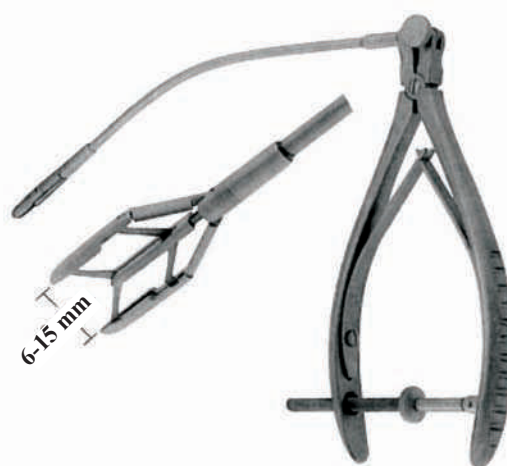

**COOLEY**  
10-179-00  
Blade Opening  
From 8 To 15 cm



**Thoracic / cardiovascular – инструменты  
для торакально-кардиоваскулярной хирургии**



**NABATOFF**  
10-180-000  
varicose vein probe  
set complete



10-181-000  
Plastic Probe tip



10-182-000  
3 mm Ø  
Olive



10-183-000  
6 mm Ø  
Olive



10-184-000  
9 mm Ø  
Olive



10-185-000  
12 mm Ø  
Olive

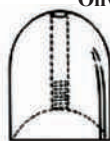

10-186-000  
15 mm Ø  
Olive

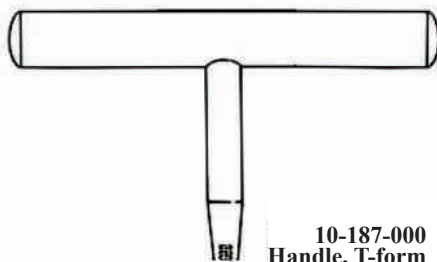

10-187-000  
Handle, T-form



**JOHN-HOPKINS**  
10-188-000

***Thoracic / cardiovascular – инструменты  
для торакально-кардиоваскулярной хирургии***



**COOLEY**  
10-189-000  
lateral blades  
12 x 16 mm  
spreading 95 mm

**COOLEY**  
10-190-000 lateral blades 15 x 30 mm, spreading 140 mm  
10-191-000 lateral blades 21 x 44 mm, spreading 150 mm



**COOLEY**  
10-192-000  
lateral blades  
35 x 50 mm  
spreading 300 mm

**FINOCCHIETTO**  
10-193-000  
lateral blades  
15 x 15 mm, spreading 75 mm

**Thoracic / cardiovascular – инструменты  
для торакально-кардиоваскулярной хирургии**



**HAIGHT**  
10-194-000  
lateral blades 30 x 30 mm  
spreading 120 mm

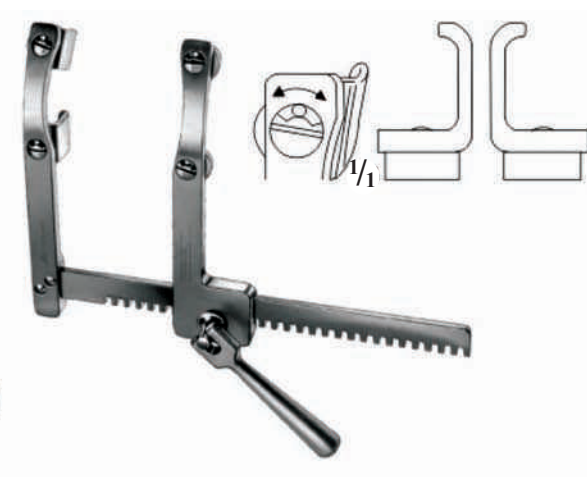

**MORSE-FAVALORO STERNAL**  
10-195-000  
4 movable blades 17 x 22 mm,  
spreading 160 mm for children



**MORSE STERNAL**  
10-196-000  
4 movable blades 27 x 22 mm,  
spreading 200 mm for adults



**TUFFIER RIB**  
10-197-000  
lateral blades 45 x 45 mm  
spreading 160 mm

**Thoracic / cardiovascular – инструменты  
для торакально-кардиоваскулярной хирургии**

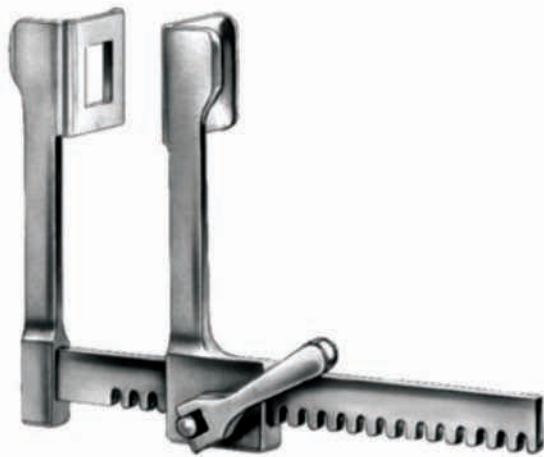

**FINOCCHIETTO, BABY**  
10-198-000  
lateral blades 14 x 15 mm  
spreading 75 mm

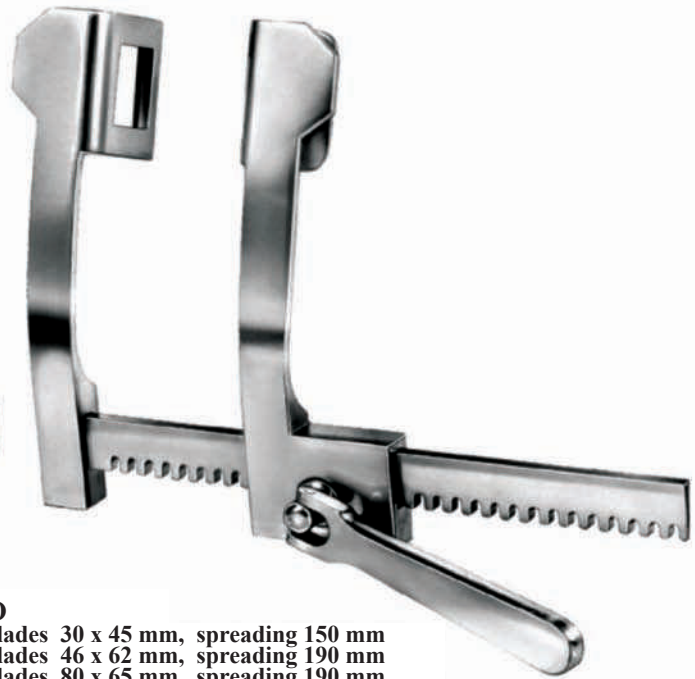

**FINOCCHIETTO**  
10-199-000 lateral blades 30 x 45 mm, spreading 150 mm  
10-200-000 lateral blades 46 x 62 mm, spreading 190 mm  
10-201-000 lateral blades 80 x 65 mm, spreading 190 mm



**THORACIC**  
10-202-000  
Complete set  
with 1 pairs of blade

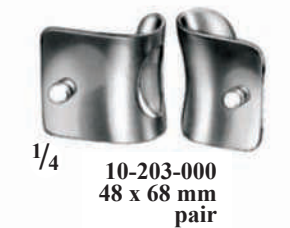

1/4  
10-203-000  
48 x 68 mm  
pair



1/4  
10-204-000  
70 x 75 mm  
pair



**THORACIC & I.M.A**  
10-205-000 Complete set  
10-206-000 lateral blades for I.M.A Retractor  
left 40 x 50 x 80 mm  
10-207-000 lateral blades for I.M.A Retractor  
Right 40 x 50 x 80 mm

*Thoracic / cardiovascular – инструменты  
для торакально-кардиоваскулярной хирургии*



**BURFORD / FINOCCHIETTO**  
10-208-180  
18 cm  
spread with 2 sets of Blades  
65 x 62 mm  
47 x 62 mm

*Thoracic / cardiovascular – инструменты  
для торакально-кардиоваскулярной хирургии*



**SAUERBRUCH-FREY**  
10-209-370  
for the first rib  
37 cm



**SCHUMACHER**  
10-210-210  
sternum shears  
21 cm



**BONE SHEAR**  
10-211-230  
23 cm



**RIB SHEAR**  
10-212-230  
23 cm



**GLUCK**  
10-213-210  
21 cm



**LEBSCHE**  
STERNUM  
CHISEL  
10-214-245  
24.5 cm

**Thoracic / cardiovascular – инструменты  
для торакально-кардиоваскулярной хирургии**

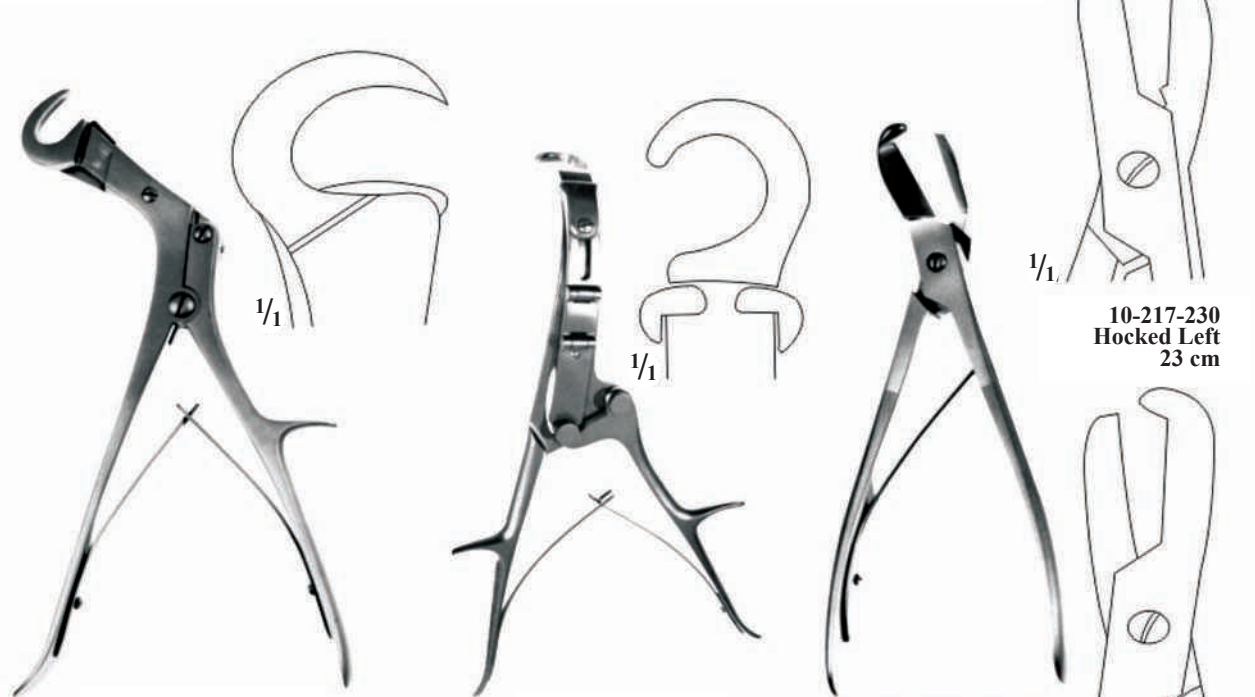

**GIERTS-SEMB**  
10-215-280  
28 cm

**BRUNNER**  
10-216-335  
33.5 cm

**MAURER-COLLIN**

1/1  
**10-217-230**  
Hocked Left  
23 cm

1/1  
**10-218-230**  
Hocked Right  
23 cm



**COLLIN**  
10-219-190  
19 cm

**DOYEN**  
10-220-190  
19 cm

**SAUERBRUCH**  
10-221-240 24 cm For Children,  
10-222-270 27 cm For Adults,

**SCHUARDT**  
10-223-170  
17 cm